



OPCW

Technical Secretariat

S/1731/2019
1 March 2019
Original: ENGLISH

NOTE BY THE TECHNICAL SECRETARIAT

**REPORT OF THE FACT-FINDING MISSION REGARDING THE INCIDENT
OF ALLEGED USE OF TOXIC CHEMICALS AS A WEAPON
IN DOUMA, SYRIAN ARAB REPUBLIC, ON 7 APRIL 2018**



1. INTRODUCTION

This document contains the final report¹ on the work of the OPCW Fact-Finding Mission in Syria (FFM) regarding the alleged use of toxic chemicals as a weapon in Douma, the Syrian Arab Republic, on 7 April 2018. The work of the FFM was conducted in accordance with preambular paragraph 8 and operative paragraphs 5 and 6 of decision EC-M-48/DEC.1 (dated 4 February 2015) and other relevant decisions of the OPCW Executive Council (hereinafter “the Council”), as well as under the Director-General’s authority to seek to uphold at all times the object and purpose of the Chemical Weapons Convention, as reinforced by resolutions 2118 (2013) and 2209 (2015) of the United Nations Security Council as applicable to this investigation. The mandates for the investigation of the alleged incident are referenced in note verbale NV/ODG/214589/18 (dated 10 April 2018) of the Technical Secretariat (hereinafter “the Secretariat”) and note verbale No. 38 of the Syrian Arab Republic (dated 10 April 2018).

2. SUMMARY

- 2.1 On 10 April 2018, the Secretariat and the Permanent Representation of the Syrian Arab Republic to the OPCW exchanged notes verbales with regard to urgently dispatching a Fact-Finding Mission (FFM) team to Damascus to gather facts regarding the incident of alleged use of toxic chemicals, as a weapon, in Douma on 7 April 2018. An advance team was dispatched on 12 April and a follow-on team the next day, with the full complement arriving in Damascus on 15 April. A second team deployed to a different location on 16 April to conduct further activities in relation to the allegation.
- 2.2 The FFM team could not enter Douma until almost a week after arrival due to the high security risk to the team, which included the presence of unexploded ordinance, explosives and sleeper cells still suspected of being active in Douma. On 18 April, during a reconnaissance visit to two sites of interest, the security detail was confronted by a hostile crowd and came under small arms fire and a hand-grenade explosion. The incident reportedly resulted in two fatalities and one injury.²
- 2.3 On 21 April, the FFM team conducted its first visit to one of the sites of interest after security concerns had been addressed and it was deemed safe to enter Douma. The team made four additional deployments to other sites of interest over the following ten days, including two on-site visits to a warehouse and a facility suspected by the Syrian Arab Republic Authorities of producing chemical weapons. There were no further security incidents during the on-site visits and the FFM team was at all times isolated from local crowds and media personnel, thereby allowing it to conduct its activities without interference. At one location, the team was unable to gain full access to apartments of interest.³

¹ An interim report was previously issued by the Secretariat (S/1645/2018, dated 6 July 2018).

² Details on security and access are available in Section 6.

³ Reasons are explained in paragraphs 6.9 and 8.22.

- 2.4 The FFM activities regarding the Douma alleged incident included: (a) on-site visits; (b) chemical detection; (c) environmental sample collection and receipt; (d) biomedical sample collection and receipt; and (e) witness and casualty interviews, including on Syrian territory. These activities were conducted following stringent procedures of the OPCW.
- 2.5 All the environmental samples from Douma were collected by the FFM team on Syrian territory in the presence of representatives of the Syrian Arab Republic. Fractions of the aforementioned samples were handed over by the FFM to the Syrian National Authority representative.
- 2.6 Based on the levels of chlorinated organic derivatives, detected in several environmental samples gathered at the sites of alleged use of toxic chemicals (Locations 2 and 4), which are not naturally present in the environment, the FFM concludes that the objects from which the samples were taken at both locations had been in contact with one or more substances containing reactive chlorine.⁴
- 2.7 No organophosphorous nerve agents, their degradation products or synthesis impurities were detected either in environmental samples prioritised for analysis or in plasma samples from alleged casualties.
- 2.8 Apart from the Schedule 3.B.17 chemical triethanolamine and a Schedule 2.B.04 chemical known as “AmgardV19”, the presence of which was satisfactorily explained,⁵ no other scheduled chemicals listed in the Annex on Chemical to the Chemical Weapons Convention, or their degradation products, were detected in the environmental samples analysed.
- 2.9 From the analysis of the information gathered during the on-site visits to the warehouse and facility suspected of producing chemical weapons, there was no indication of either facility being involved in their manufacture. The information collected indicates that the activities at both locations were mostly related to the production of explosives.
- 2.10 Witnesses reported to the FFM team that there were 43 decedents related to the alleged chemical incident, most of whom were seen in videos and photos strewn on the floor of multiple levels of an apartment building and in front of the same building. Additionally, several witnesses reported seeing decedents in the basement of the building, on multiple floors of the building, on the streets and inside the basements of several buildings within the same area. A United Nations agency also reported cases of death by exposure to a toxic chemical.⁶ However, the team did not have direct access to examine dead bodies, as it could not enter Douma until two weeks after the incident (see paragraph 2.2), by which time the bodies had been buried.

⁴ Reactive chlorine (RC) is the combined concentration of various chlorine species able to react and interconvert in a given environment. It includes free available chlorine (chloride ions), hypochlorous acid and the hypochlorite ion. Further details are present in Paragraphs 8.6 to 8.15.

⁵ Paragraph 8.7.

⁶ United Nations Human Rights Council (HRC) report, 38th Session, 20 June 2018 (A/HRC/38/CRP.3) and HRC report to the General Assembly, 39th Session, 10 – 28 September 2018 (A/HRC/39/65).

- 2.11 Many of the signs and symptoms reported by the medical personnel, witnesses and casualties (as well as those seen in multiple videos provided by witnesses), their rapid onset, and the large number of those reportedly affected, indicate exposure to an inhalational irritant or toxic substance. However, based on the information reviewed and with the absence of biomedical samples from the dead bodies or any autopsy records, it is not currently possible to precisely link the cause of the signs and symptoms to a specific chemical.
- 2.12 Two yellow industrial cylinders dedicated for pressurised gas with dimensions of approximately 1.4 x 0.4 meters were observed by the FFM team at two separate locations (Locations 2 and 4).⁷
- 2.13 The team analysed the available material and consulted independent experts in mechanical engineering, ballistics and metallurgy who utilised specialised computer modelling techniques to provide qualified and competent assessments of the trajectory and damage to the cylinders found at Locations 2 and 4.
- 2.14 The analyses indicated that the structural damage to the rebar-reinforced concrete terrace at Location 2 was caused by an impacting object with a geometrically symmetric shape and sufficient kinetic energy to cause the observed damage. The analyses indicate that the damage observed on the cylinder found on the roof-top terrace, the aperture, the balcony, the surrounding rooms, the rooms underneath and the structure above, is consistent with the creation of the aperture observed in the terrace by the cylinder found in that location.
- 2.15 At Location 4, the results of the studies indicated that the shape of the aperture produced in the modulation matched the shape and damage observed by the team. The studies further indicated that, after passing through the ceiling and impacting the floor at lower speed, the cylinder continued an altered trajectory, until reaching the position in which it was found.
- 2.16 Based on the analysis results of the samples taken by the FFM from the cylinders, their proximity at both locations, as well as the analysis results of the samples mentioned under paragraph 2.6, it is possible that the cylinders were the source of the substances containing reactive chlorine.⁸
- 2.17 Regarding the alleged use of toxic chemicals as a weapon on 7 April 2018 in Douma, the Syrian Arab Republic, the evaluation and analysis of all the information gathered by the FFM—witnesses' testimonies, environmental and biomedical samples analysis results, toxicological and ballistic analyses from experts, additional digital information from witnesses—provide reasonable grounds that the use of a toxic chemical as a weapon took place. This toxic chemical contained reactive chlorine. The toxic chemical was likely molecular chlorine.

⁷

A detailed description of the cylinders is present in Annexes 6 and 7.

⁸

Paragraphs 8.9 to 8.18.

3. BACKGROUND

- 3.1 On 7 April 2018, reports began to circulate on social media and in the press regarding an alleged chemical attack that had taken place at around 16:00 local time on the same day in Douma, a district of eastern Ghouta in Damascus, the Syrian Arab Republic, and another attack the same evening at approximately 19:30. Casualty levels ranging from 40 to 70 deaths, including large numbers of children, and hundreds of chemical-related injuries, were reported. There were mixed reports of what toxic chemicals had been used, with some citing chlorine and others citing sarin, or a mixture of both substances. Images and videos posted online showed casualties in a residential building as well as victims being treated at a hospital, reportedly for chemical exposure. Photos and videos of cylinders allegedly used in the two attacks were also posted online.
- 3.2 Widespread condemnation of the incident ensued, with armed opposition groups assigning responsibility for the alleged incident to the forces of the Syrian Arab Republic. The latter denied the attack and accused the media wing of Jaysh al Islam of fabricating the incident to incriminate the Syrian Arab Army.
- 3.3 On 10 April 2018, the Secretariat sent Note Verbale No. NV/ODG/214589/18 to the Syrian Arab Republic expressing its intention to deploy a team to Damascus. This correspondence coincided with Note Verbale No. 38 from the Permanent Representation of the Syrian Arab Republic to the OPCW requesting the FFM team to be dispatched urgently to visit the town of Douma to verify the information surrounding the alleged use of toxic chemicals on 7 April 2018. On the same day, the Permanent Representative of the Russian Federation to the OPCW submitted a letter to the Director-General in which he welcomed the request of the Syrian Arab Republic and pledged to facilitate the work of the FFM.
- 3.4 An advance team was mobilised and dispatched on 12 April 2018 with a follow-on team the next day. The FFM entered the Syrian Arab Republic on 14 April 2018.

4. AIMS AND SCOPE OF THE FFM

- 4.1 The aim of the FFM, as specified in Mandate FFM/050/18, was to gather facts regarding the incident of alleged use of toxic chemicals as a weapon, in Douma, in eastern Ghouta, the Syrian Arab Republic, on 7 April 2018, as reported in the media, and to report to the Director-General upon conclusion of the FFM activities. The site for investigation included Damascus and any other relevant sites, subject to consultation with the Government of the Syrian Arab Republic and in accordance with paragraphs 12 and 13 of the FFM Terms of Reference. The operational instructions were to:
- review and analyse all available information pertaining to the reported incident of alleged use of toxic chemicals, as a weapon;
 - collect testimonies from persons alleged to have been affected by the use of toxic chemicals, as a weapon, including those who underwent treatment; eye-witnesses of the alleged use of toxic chemicals; medical personnel who had provided treatment to persons who had been treated or came into contact with persons who might have been affected by the alleged use of toxic chemicals;

- where possible, and deemed necessary, carry out medical examinations, including autopsies, and collect biomedical samples of those alleged to have been affected;
- if possible, visit hospitals and other locations as deemed relevant to the conduct of its investigations;
- examine and, if possible, collect copies of hospital records, including patient registers, treatment records, and any other relevant records as deemed necessary;
- examine and, if possible, collect copies of any other documentation and records deemed necessary;
- take photographs and video recordings and examine and, if possible, collect copies of video and telephone records;
- if possible and deemed necessary, physically examine and collect samples from remnants of munitions, devices, cylinders, containers, etc., alleged to have been used during the incident under investigation;
- if possible and deemed necessary, collect environmental samples at or from the alleged points of incident and surrounding area;
- arrange transport for the off-site analysis of the collected samples; and
- undertake activities in accordance with the relevant Technical Secretariat procedures relating to the conduct of inspections during contingency operations, as applicable.

4.2 On 20 April, the Syrian Arab Republic submitted a note verbale to the Secretariat formally requesting the Director-General to instruct the FFM team to carry out a visit, within the framework of its mission to gather facts surrounding the allegation on 7 April 2018, to a warehouse suspected of storing chemicals related to the production of chemical weapons.

4.3 Three further mandates (FFM/049/18, FFM/051/18, and FFM/057/18) were issued by the Director-General instructing the FFM team to conduct further activities in relation to the investigation of alleged use of toxic chemicals as a weapon in the Syrian Arab Republic on 7 April 2018.

5. PRE-DEPLOYMENT ACTIVITIES AND TIMELINE

5.1 Following reports in the media of the alleged incident on 7 April, the Information Cell of the Technical Secretariat immediately informed the FFM team and initiated a search of open-source information to assess the credibility of the allegation. The major sources comprised news media, blogs and the websites of various non-governmental organisations (Annex 2). The final assessment by the Information Cell was that the credibility of the allegation was high, and the Director-General, based on this information, initiated an on-site investigation.

5.2 The FFM team, comprising nine inspectors and two interpreters, was mobilised on 9 April 2018 and pre-deployment activities commenced immediately. Preparations were made to deploy an advance team of three inspectors and an interpreter on 12 April and a follow-on team the next day. The team was briefed by the Information Cell on all the relevant information gathered to date. A detailed timeline of the key events of the mission is provided in Annex 3.

6. SECURITY AND ACCESS TO THE SITES OF THE ALLEGED INCIDENTS

- 6.1 Given the recent military activities and the volatile situation in Douma at the time of the FFM deployment, security and safety considerations were of paramount importance. Considerable time and effort were invested in discussions and planning to mitigate the inherent security risks to the FFM team and others deploying to Douma. According to Syrian Arab Republic and Russian Military Police representatives, there were a number of unacceptable risks to the team, including mines and explosives that still needed to be cleared, a risk of explosions, and sleeper cells still suspected of being active in Douma. This assessment was shared by the representative of the United Nations Department of Safety and Security (UNDSS). Moreover, the operation to evacuate residents who had accepted an offer to leave Douma was ongoing, using the same road the team would have to take.
- 6.2 At the outset, the FFM team stated that, as general rule, the security of the mission is the responsibility of the hosting State Party to the Chemical Weapons Convention. During the initial meetings in Damascus, the FFM team was informed by Syrian and Russian representatives that the Syrian Arab Republic could guarantee the safety of the FFM team only if the security was provided jointly with the Russian Military Police.
- 6.3 Following consultations with OPCW Headquarters, it was agreed between the Secretariat, the Syrian Arab Republic, the Russian Military Police, the United Nations Office for Project Services (UNOPS), and UNDSS representatives that security within Douma could be provided by the Russian Military Police. This was formalised on 16 April 2018. Consequently, it was agreed that the Syrian Arab Republic would provide security from the hotel where the inspectors were staying to the final checkpoint at El Wafadin before entering Douma. From that point on, the Syrian Arab Republic would relinquish responsibility for security to the Russian Military Police. It was also agreed that the FFM team would be accompanied by Syrian Arab Republic representatives during the on-site activities, with Russian personnel limited to providing security.
- 6.4 During the reconnaissance visit by UNDSS on 18 April 2018 to assess the first two locations planned to be visited the following day, the security detail was confronted by a hostile crowd and came under fire from small arms and a hand grenade that exploded at Location 2 (for locations see Figure 2 in Section 8 below). The incident reportedly resulted in two fatalities and an injury to a Russian soldier.
- 6.5 Following the incident, the planned deployment of the FFM team was postponed until the security situation could be reassessed. Additional measures to mitigate the high security risks were proposed by the UNDSS representative, and included:
- (a) clearing the areas to be visited by the FFM team;
 - (b) securing the areas during the 24-hour period before deployment;
 - (c) increasing the number of escorts and having advance teams from the UNDSS and the Russian Military Police monitor the area prior to the arrival of the team at the sites;
 - (d) using the police force for crowd control;

- (e) minimising the movement of civilians near the areas of interest given the possibility of suicide bombers getting within close proximity of the inspection team; and
 - (f) deploying snipers on rooftops around the sites of interest.
- 6.6 New routes of access to the locations of interest were identified and modifications to the initial FFM deployment plans were formulated. These included reducing the size of the FFM team deploying to the field to facilitate better security control and limiting the number of sites to be visited during each deployment. All parties agreed that media reports and public pronouncements on operational aspects of the FFM were compounding the security risk for the team, and efforts were made to mitigate this risk element.
- 6.7 Once the security reassessment had been concluded and the proposed additional mitigation measures implemented, the FFM team deployed to the sites of investigation in accordance with the updated priorities and proposed schedule.
- 6.8 For the remainder of the mission, the deployment by the FFM team proceeded without any security incidents. Access was granted to locations identified by the team as soon as adequate security conditions could be assured by the Syrian Arab Republic, the Russian Military Police, and the UNDSS. The Russian Military Police ensured that the team was fully isolated from local crowds and media personnel during the on-site visits, thereby allowing it to conduct its activities without interference.
- 6.9 The FFM visited Location 4 (see Figure 2) on two occasions. During the visit to Location 2, Syrian Arab Republic representatives did not provide the access requested by the FFM team to some apartments of interest within the building, which were closed at the time. The Syrian Arab Republic representatives stated that they did not have the authority to force entry into the locked apartments.

7. MISSION ACTIVITIES

Methodological considerations

- 7.1 The FFM followed the same general methodology outlined in previous FFM reports, with the team adhering throughout its deployment to the most stringent protocols available.⁹ Three FFM sub-teams were deployed to two locations at different time intervals to conduct activities relevant to the respective mandates.
- 7.2 Environmental sampling at the alleged incident sites in Douma was conducted by the FFM team, using its own equipment and ensuring chain of custody throughout the operation in accordance with OPCW standard operating procedures (SOPs), work instructions (WIs) and guidelines. Samples were collected, sealed, and documented in photos and video recordings in the presence of Syrian Arab Republic representatives and unpacked at the OPCW Laboratory for splitting and redistribution to the OPCW

⁹ The FFM team based its findings on whether there were reasonable grounds to believe that chemical weapons were used, based on a reliable body of evidence consistent with other information tending to show that an incident or event happened (Annex 13 [6,8, 13]) Note: Numbers in square brackets are references to the bibliography in Annex 13 to this report.

designated laboratories in the presence of a representative of the Syrian Arab Republic.

- 7.3 Additional environmental and biological samples were received by the FFM from witnesses (Annex 5). From the moment of receipt, these samples were handled as described above. The FFM team also directly oversaw the drawing of blood samples from witnesses who reported being exposed to toxic chemicals in Douma on 7 April 2018.
- 7.4 Interviews were conducted by inspectors proficient in interviewing techniques, following the strict procedures set out in the OPCW WIs. Prior to commencing the interviews, the process was described to the interviewee, with emphasis on the fact that, with the consent of the interviewee, the interviews would be audio and/or video recorded. After confirming that the process had been understood, interviewees were requested to sign a consent form. The interview process followed the free-recall approach, with follow-up questions to elicit information of potential evidentiary value and to clarify aspects of the testimony.
- 7.5 Open-source materials including, but not limited to, videos and photos were used primarily for planning activities, but also for comparative purposes with material directly collected by the FFM team during the course of the investigation. However, the conclusion of the investigation does not rely on data and information gathered from open sources.

Activities

- 7.6 The individual activities of the FFM were conducted in accordance with OPCW guidelines as well as SOPs and WIs (Annex 1).
- 7.7 The activities included:
 - (a) collecting environmental samples at sites relevant to the alleged incident, namely Locations 1, 2, and 4, as well as at two additional locations; one suspected by the Syrian Arab Republic authorities of producing chemical weapons and the other suspected to be a warehouse;
 - (b) receiving and documenting biomedical and environmental samples brought by alleged casualties or witnesses, as well as overseeing the direct taking of blood samples;
 - (c) taking photographs and collecting data on the cylinders found at Locations 2 and 4, and of the physical surroundings;
 - (d) taking photographs and collecting data from a warehouse and a facility suspected by the authorities of the Syrian Arab Republic of producing chemical weapons;
 - (e) conducting interviews with medical staff, casualties, first responders and witnesses of the alleged chemical attack in Douma;

- (f) reviewing open-source materials (see paragraph 7.5 above for use of open-source materials);
- (g) tagging of two cylinders; and
- (h) consulting independent experts in toxicology, ballistics, structural engineering and metallurgy.

7.8 The possibility of exhuming bodies from mass graves to collect biomedical samples and examining bodies reportedly exposed to toxic chemicals from the alleged attack on 7 April 2018 was considered by the Secretariat. The intention to do so was communicated to the Syrian Arab Republic in Note Verbale NV/ODG/214827/18, and preliminary preparations were undertaken by the Secretariat for this eventuality. The Syrian Arab Republic replied in Note Verbale No. 45 on 4 May 2018 and enumerated the conditions to be met in order to conduct the exhumation. With due consideration of the time elapsed since the alleged incident, the possibility was eventually not explored any further.

8. FACTUAL FINDINGS

Alleged sites

8.1 The sites visited during the FFM deployment included Location 1, Location 2 and Location 4, which refer to the hospital where victims were allegedly treated for chemical exposure, the residential block with the cylinder on the roof terrace, and the apartment with the cylinder found in the bedroom, respectively. Location 3 was initially considered a site of interest, but was discarded based on subsequent information. Two other locations, a facility and a warehouse, were visited to gather information to assess any possible connection with chemical weapons manufacture. Locations 1 to 4 are shown on the satellite images of Douma below.

FIGURE 1: LOCATION OF DOUMA IN SYRIA



FIGURE 2: LOCATIONS (1-4) OF INTEREST TO THE FFM IN DOUMA



FIGURE 3: INDIVIDUAL LOCATIONS OF INTEREST TO THE FFM IN DOUMA

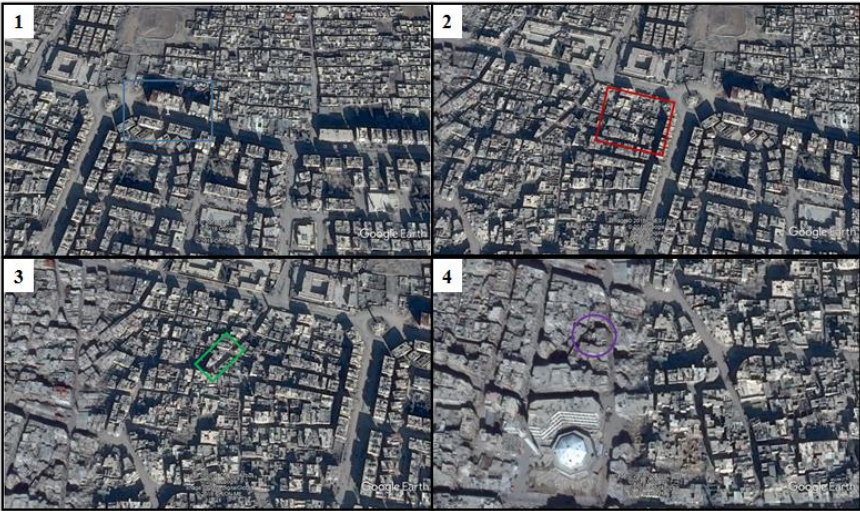
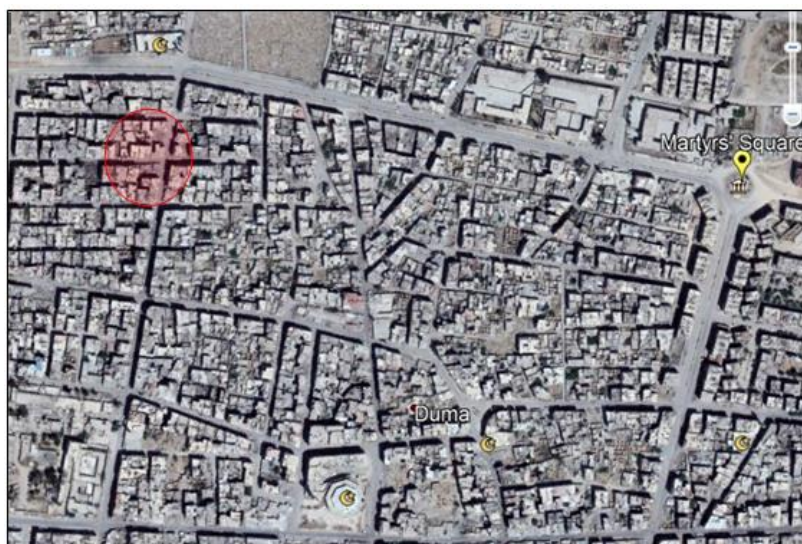

FIGURE 4: OTHER AREAS OF INTEREST IN PROXIMITY TO LOCATION 2



Figure 4 shows the area around Location 2, the vehicles' tunnel to Point One (Location 1) and areas mentioned by witnesses. The white shaded area is the general location where witnesses reported having perceived a strong odour. The red shaded areas are buildings/houses/places where witnesses reported being affected by a chemical.

FIGURE 5: OTHER AREAS OF INTEREST



The red shaded area was reported to be the location of an alleged chlorine attack at approximately 16:00 on 7 April 2018.

8.2 The meteorological conditions in Douma on 7 April around the time of the alleged incident, as registered in open sources (darksky.net), are shown in Table 1 below.

TABLE 1: METEOROLOGICAL CONDITIONS IN DOUMA ON 7 APRIL 2018

Time	Temperature	Wind Direction	Wind Speed	Precipitation	Clouds	Humidity
19:00	26°C	From SE	11 Km/h	0.0mm	overcast	27 %

Sampling

8.3 The FFM team formulated detailed sampling plans for each site of allegation. The plans relied on robust scientific principles, buttressed where possible by peer-reviewed scientific literature or proven experience, to identify sample types and locations of greatest potential probative value to the mission. Details of the scientific rationale behind the sampling process are given in Annex 4.

8.4 The team executed the original sampling plans to the extent possible, adapting to the conditions on site where necessary.

8.5 Given the number of locations visited and the diversity of potential evidentiary material available, 129 samples in total were collected and transported to the OPCW Laboratory. To expedite analysis of those environmental samples considered to be of greatest probative value or of highest susceptibility to degradation, 31 samples were selected for the first round of analysis by the OPCW designated laboratories. An

additional batch of 13 samples was sent for a second round of analysis at a later stage. The results of analysis are presented in Annex 5.

Discussion of analysis results

- 8.6 The results of analysis of the prioritised samples submitted to the designated laboratories were received by the FFM team on 22 May 2018 and 8 February 2019. No organophosphorus nerve agents or their degradation products were detected, either in the environmental samples or in plasma samples from the alleged casualties. Various chlorinated organic chemicals were found in samples from Locations 2 and 4, along with explosive residue. These results are reported in Annex 5.
- 8.7 No scheduled chemicals or degradation products of scheduled chemicals were detected except: (a) the Schedule 3.B.17 chemical triethanolamine, which was detected at trace levels in various clothing samples belonging to alleged victims and in grouting from the tunnel beneath the hospital (Location 1); and (b) a Schedule 2.B.04 chemical known as “AmgardV19” which was detected at trace levels in one item of clothing of one alleged victim. The presence and concentration of both chemicals are readily explained given their common use in surfactant and flame retardant formulations in textiles.¹⁰
- 8.8 Other compounds detected across a broad range of samples included 2,4,6-trinitrotoluene (TNT), chlorinated derivatives of acetic acid, various mono-, di- and trichlorophenols and chloral hydrate. All wood samples showed varying amounts of bornyl chloride or alpha-pinene (or both).¹¹
- 8.9 Although chlorine decomposes rapidly in the environment, the gas itself or its decomposition products are known to react with a variety of other chemicals in the environment, including organic materials and metals. Such products can be quite stable and therefore can provide long-lived chemical signatures of chlorine exposure. The presence of chlorine-reactive species is based primarily on the detection of bornyl chloride and/or trichlorophenol in the wood samples. Bornyl chloride is a chemically-stable chlorinated derivative of alpha-pinene, a common terpene-type compound found mainly in coniferous wood [1]. When exposed to chlorine, alpha-pinene can be converted to bornyl chloride which is a chemical not naturally present in the environment. Although molecular chlorine (chlorine gas) does not react directly with alpha-pinene, hydrogen chloride, a decomposition product of molecular chlorine, is known to readily react with it to generate bornyl chloride [1] [2]. Two of the wood samples collected at the alleged sites showed the presence of bornyl chloride.
- 8.10 Based on these findings alone, it cannot be unequivocally stated that the wood was exposed to chlorine gas, rather than to hydrogen chloride or hydrochloric acid. Other chemicals such as phosgene or cyanogen chloride, which also decompose to give hydrogen chloride or hydrochloric acid, also could theoretically give rise to bornyl chloride from interaction with alpha-pinene in the wood.

¹⁰ Annex 5, Table A5.1, entries 31, 32, and 33.

¹¹ Annex 5, Table A5.1, entries 7, 12, 14, 22, and 30.

- 8.11 In all wood samples analysed, an analogue of phenol, trichlorophenol was also detected. Like bornyl chloride, this compound is not naturally present in wood; and, in experiments conducted by one designated laboratory, the chlorinated phenol could be generated by exposing wood samples to chlorine gas.
- 8.12 One of the methods by which phenol can undergo ring chlorination is through a process known as electrophilic aromatic substitution with hypochlorous acid, a disproportionation product of molecular chlorine [3]. Hydrochloric acid, the decomposition product of phosgene and cyanogen chloride, on the other hand, does not chlorinate phenols and consequently neither phosgene nor cyanogen chloride should give rise to the trichlorophenol found in the samples. This observation would tend to confirm that the toxic chemical containing reactive chlorine was neither phosgene nor cyanogen chloride, at least not as the only chemical present.
- 8.13 It should be noted that phenol can also be chlorinated to trichlorophenol with sodium hypochlorite, the main component of chlorine-based bleach [4] [5].
- 8.14 In addition to bornyl chloride and trichlorophenol being detected in the wood samples, various other chlorinated compounds such as di and trichloroacetic acid as well as chloral hydrate were found in soil, concrete, wood and textile samples taken at the alleged incident sites. These are all compounds that are not generally present naturally in the environment and can be generated from reaction with active chlorine species (e.g., molecular chlorine, hypochlorous acid, sodium hypochlorite or chlorine-based bleaching agents) [5]. Studies have demonstrated that, when humic material in soil or sewage, for example, is mixed with active chlorine solutions, various chlorinated acetic acids, chloroaldehydes chlorinated phenols, among others, are formed [5]. Many such compounds were detected in the samples analysed.
- 8.15 The findings discussed in paragraphs 8.9 to 8.14 indicate that a substance, or a combination of substances (such as molecular chlorine, hypochlorous acid or sodium hypochlorite) containing a reactive chlorine atom was in contact with many of the samples collected at both alleged incident sites (Locations 2 and 4).
- 8.16 At Location 4, the team observed visible signs of corrosion on the metallic objects present in the apartment, such as the chandelier, the bedside lamps, pipes, and drawer handles, in addition to the cylinder itself, the valve and the harness. The corrosion of all metal objects is a clear indication of their exposure to a corrosive substance. At Location 2, some corroded objects were also observed. However, the FFM team was unable to establish whether the corrosion was related to a corrosive substance or to natural factors. At both locations, there were no visible signs of a bleach agent or discoloration due to contact with a bleach agent.
- 8.17 Based on the sample analysis and the observation on site, there were reasonable grounds to indicate that the environment in both locations was in contact with molecular chlorine or hypochlorous acid. Knowing that hypochlorous acid is a disproportionation product of molecular chlorine in contact with water, there were reasonable grounds to indicate that molecular chlorine was present first in that environment.
- 8.18 The analysis results (Annex 5) of the samples taken by the FFM from the cylinders and their proximity to other sampled points exposed to reactive chlorine at both

locations, show higher levels of chloride in addition to the presence of chlorinated organic compounds.¹²

- 8.19 The analysis of concrete dust sample collected in the vehicles tunnel leading to Point One (Location 1) indicated the presence of three insecticides (Permethrin, Malathion and Deltamethrin), one herbicide (Linuron) and a TNT precursor (Amino dinitrotoluene) in addition to TNT, tri- and tetrachlorophenols. The detected doses of insecticides and herbicides are not toxic for human beings. The type of insecticides and herbicide detected is for agricultural and domestic use. The absence of these substances at Location 2, where dead bodies were found, excludes a link between them and the allegation.

Physical data collection

- 8.20 Aside from sampling, a large volume of information was gathered by the FFM team and included photographs, video recordings, detection measurements, dimensions of the cylinders and attached metallic structure, and the spatial arrangement in the environment of the cylinders.

Location 2 ("Cylinder on the Roof")

- 8.21 The team deployed to Location 2 (N 33° 34' 25.6'' E 36° 24' 17.3'') on 21 April 2018. Further details of the findings and analysis are contained in Annex 6.
- 8.22 During the visit to Location 2, Syrian Arab Republic representatives did not provide the access requested by the FFM team to some apartments of interest within the building, which were closed at the time. The Syrian Arab Republic representatives stated that they did not have the authority to force entry into the locked apartments. This situation was reported to OPCW Headquarters during the post-deployment debriefing that same evening.
- 8.23 The FFM had full access to other areas of interest within the same building, namely the balcony where the cylinder had allegedly impacted, the apartment directly below this, and the basement of the same apartment block.

Discussion 1: Description of Location 2 as observed by the team

- 8.24 The apartment block at Location 2 comprises five levels, namely a basement, ground, first, second and third floor. Access to each floor from the main entrance at ground level is through a central staircase that ascends counter-clockwise, with two sets of stairs and landings on each level. On the first landing of each floor, with the exception of the top floor, there is an apartment on the right and another on the left. The top floor has just one large apartment. Each level on the staircase has a tall glass-shattered window facing onto the street.
- 8.25 The central staircase does not descend into the basement and access can only be gained through an independent entrance at street level. Just below the ceiling at each end of the basement, located at either side of the entrance, there are two narrow

¹² Annex 5, Table A5.1, entries 1, 2, 3, 4, 8, 17, 20, 21, 22, and 30.

windows that open to the exterior, just above street pavement level. Inside the basement there was—what seems to be—a narrow ventilation pipe, though it was not clear to where this tube ventilated.

- 8.26 The cylinder was located on the floor of the roof terrace, on the third floor, on the east side of the building, with its nozzle poised over a circular opening in the concrete. The roof terrace where the cylinder was observed corresponds to the ceiling of a room in an apartment on the second floor.
- 8.27 The following three dimensional layouts of the apartment block depict the spatial relationship between the alleged point of impact of the cylinder and the rooms where fallen victims of the alleged chemical attack were located according to the videos provided by witnesses and their accounts.

FIGURE 6: 3D LAYOUT OF LOCATION 2 WITH DISTRIBUTION OF ROOMS AND REPORTED LOCATIONS OF ALLEGED VICTIMS

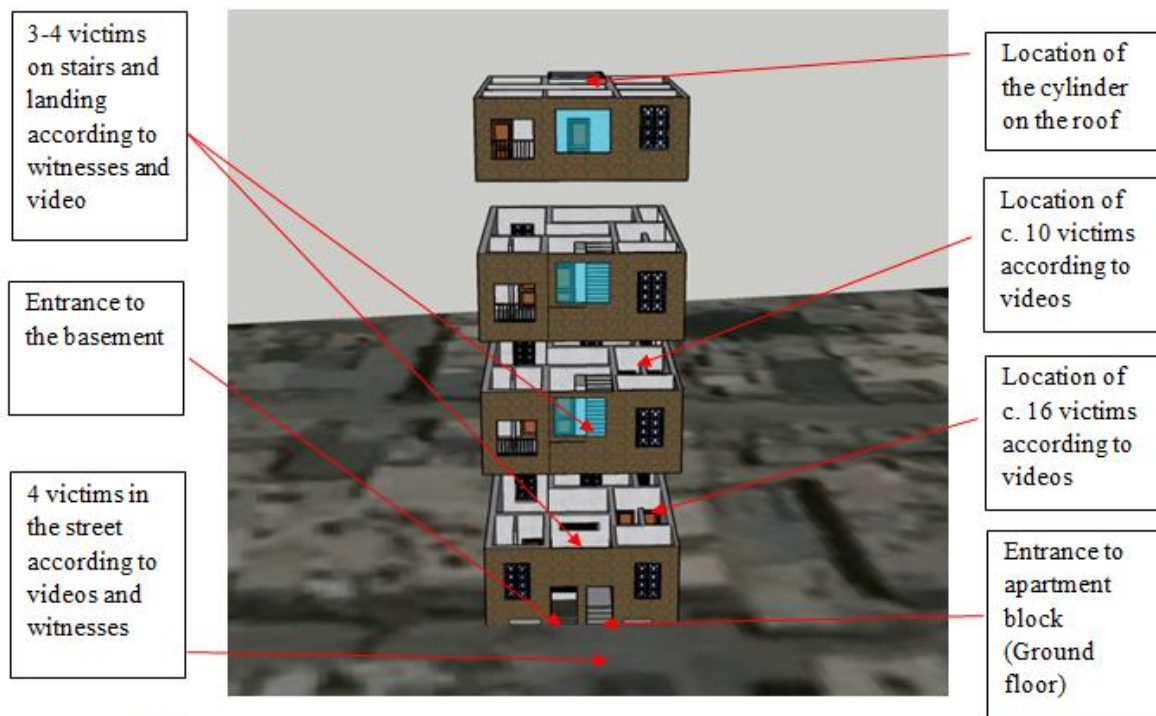

Discussion 2: Analysis of the ballistic effects of the cylinder found on the roof terrace at Location 2

- 8.28 The FFM team took numerous photos of the cylinder on the roof terrace, the aperture, the terrace and its surroundings, and the room directly beneath the aperture. The team noted the dimensions of the aperture in the rebar-reinforced concrete roof, as well as the damage to the cylinder itself.

- 8.29 The team analysed the available material and consulted independent experts in mechanical engineering, ballistics and metallurgy who utilised specialised computer modelling techniques to provide a qualified competent assessment of the trajectory and damage to the cylinders found at Location 2.
- 8.30 The expert provided reports and numerical simulations on the impact of steel cylinders against reinforced concrete slabs, reflecting the scenes found in Douma by the FFM team. The analyses include general descriptions, geometrical data, trajectory calculations, empirical calculations and numerical simulations. Furthermore, the experts used different methodologies and approaches during the analyses in order to produce more comprehensive results. Several types of proprietary, commercial and referenced/recognised software were used for the numerical simulations (Annex 12).
- 8.31 The analyses indicated that the structural damage to the rebar-reinforced concrete terrace at Location 2 was caused by an impacting object with a geometrically symmetric shape and sufficient kinetic energy to cause the observed damage. The analyses indicate that the damage observed on the cylinder found on the roof terrace, the aperture, the balcony, the surrounding rooms, and the rooms underneath and the structure above, is consistent with the creation of the aperture observed in the terrace by the cylinder found in that location.

Location 4 ("Cylinder in the Bedroom")

- 8.32 The team deployed to Location 4 (N 33° 34' 20.5'', E 36° 24' 02.8'') on 25 April, where they also took photos, measurements, and detection readings. In addition, they gathered a broad selection of samples. Photos and measurements were taken of the roof terrace where the cylinder is alleged to have penetrated and the room below where it supposedly reached its final position. Further details of the findings and analysis are contained in Annex 7.
- 8.33 From what the team observed, there did not appear to be any leakage from the cylinder at the time the team visited the location. The team noted that a slat of wood was lying under the cylinder on the bed, part of which was taken as a sample. The slat of wood was damp and softened. No chlorine gas was detected in the room by the detection equipment used by the team. The laboratory analysis showed that the wood sample had the highest content of chlorinated organic compounds of all wood samples taken.

FIGURE 7: COMPUTER-GENERATED VIEW OF THE APERTURE ON THE ROOF TERRACE

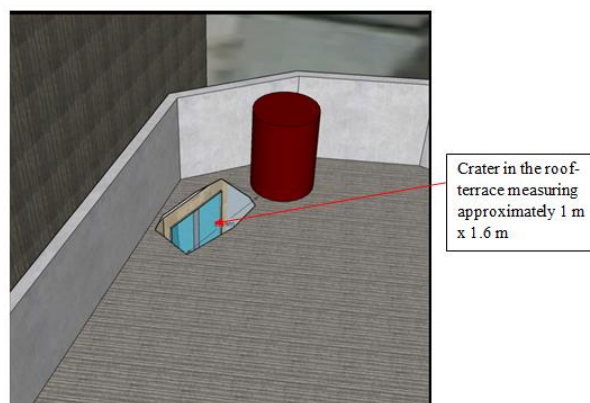

FIGURE 8: COMPUTER-GENERATED VIEW OF THE TERRACE WITH THE APERTURE FROM THE ROOF OF ADJACENT BUILDING

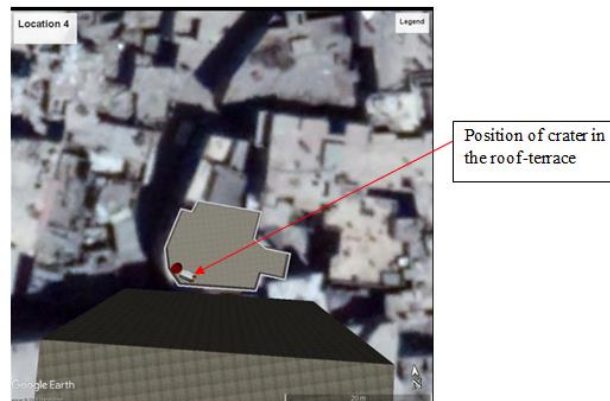

FIGURE 9: COMPUTER-GENERATED VIEW OF THE ROOF TERRACE WITH THE APERTURE AND THE NEIGHBOURING BUILDING

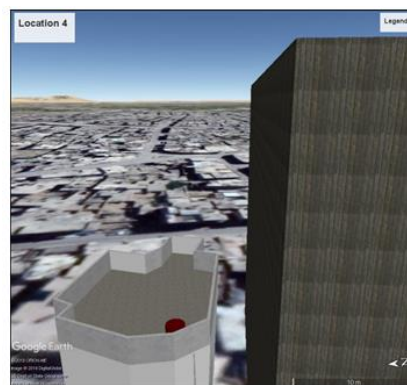

FIGURE 10: COMPUTER MODULATION OF THE APERTURE AND CYLINDER IMPACT

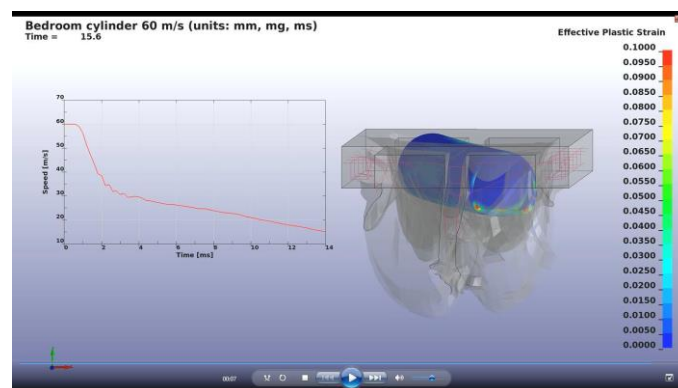
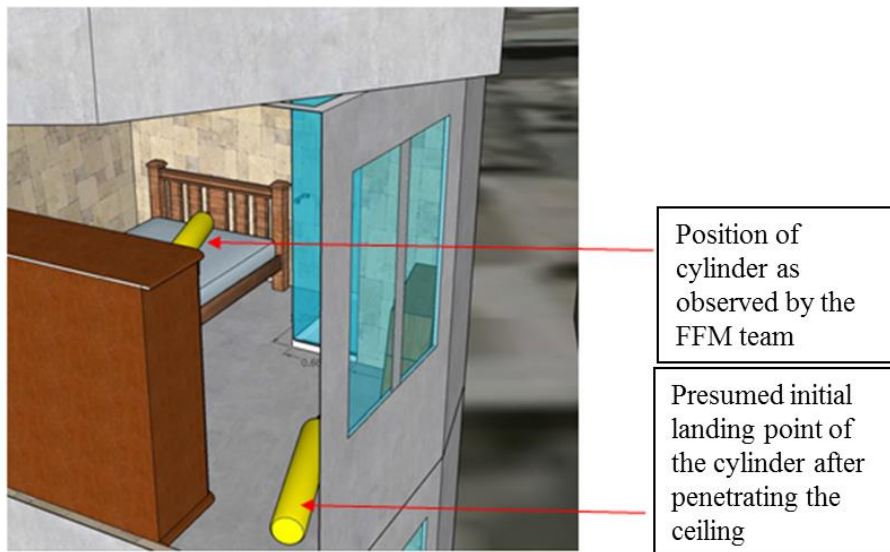
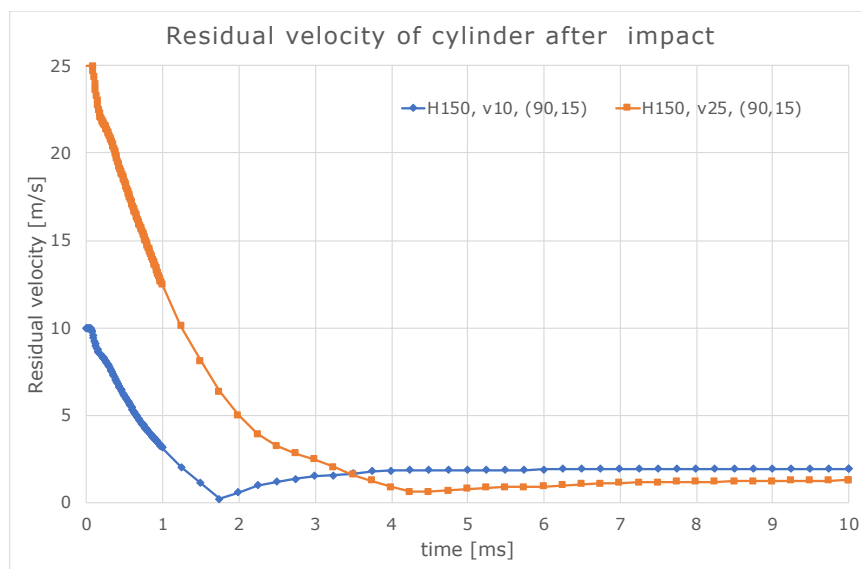

FIGURE 11: VIEW OF THE BEDROOM AND CYLINDER POSITION



8.34 The team consulted experts in mechanical engineering, ballistics and metallurgy to provide qualified, competent assessments of the cylinder trajectory. The results of these assessments indicated that the shape of the aperture produced in the modulation matched the shape and damage observed by the team. The assessments further indicated that, after passing through the ceiling and impacting the floor at lower speed, the cylinder continued altered trajectory, until reaching the position in which it was found.

FIGURE 12: DIAGRAM DEMONSTRATING THE POSSIBLE MOVEMENT OF THE CYLINDER AT LOW SPEED



8.35 In a similar manner, the FFM assessed the consistency between the structural damage appearing on the cylinder against the structural damage to the rebar-reinforced

concrete roof through which the cylinder allegedly traversed. Results are presented in Figures 13 and 14.

FIGURE 13: COMPUTER-MODULATED DAMAGE TO THE CYLINDER WHILE PASSING THROUGH THE ROOF

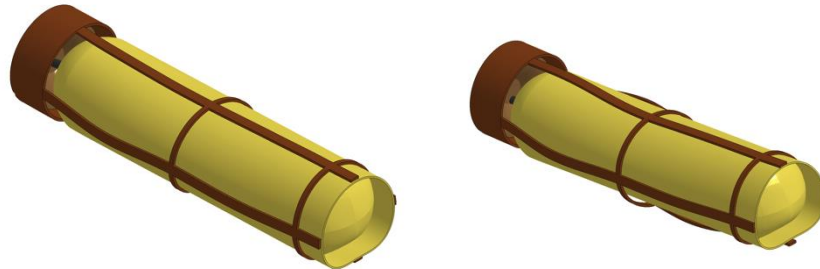

FIGURE 14: DAMAGE OBSERVED ON THE CYLINDER



Location 1 (hospital)

- 8.36 The FFM team visited Location 1 on 1 May 2018. The hospital, which is located at coordinates N 33° 34' 27.4", E 36° 24' 25.2", operates in the basement of a multi-storey building. The facility, as the team was informed, has a staff of about 200 and was conducting regular activities at the time the team visited. The facility includes an operation room, a recovery room, wards, intensive care units, a laboratory, and a pharmacy. The hospital is connected to an underground tunnel.
- 8.37 The FFM team requested information about procedures related to deceased patients in the hospital. They were informed that deceased patients normally would be taken to

“Point 200”, a room used as a morgue inside the hospital, where they would be collected by the local council. Subsequent information from witnesses indicated that the Syrian Civil Defence (SCD) assisted in this task.

- 8.38 The team was taken to the tunnel that had appeared in videos and photographs showing bodies that were reportedly the result of the alleged chemical attack, together with victims of conventional bombing. At the time of the visit of the FFM team, there were no bodies in the area of the tunnel. Samples for analysis were collected in the tunnel following the sampling plan, but no chemicals relevant to the allegation were found.

Warehouse and facility suspected by the authorities of the Syrian Arab Republic of producing chemical weapons

- 8.39 At the warehouse and the facility suspected by the authorities of the Syrian Arab Republic of producing chemical weapons in Douma, information was gathered to assess whether these facilities were associated with the production of chemical weapons or toxic chemicals that could be used as weapons. From the information gathered during the two on-site visits to these locations, there was no indication of either facility being involved in the production of chemical warfare agents or toxic chemicals to be used as weapons.
- 8.40 The collected information indicated that both facilities were related to the production of explosives. This conclusion was based on the fact that virtually all the chemicals present were common precursors for explosives manufacture and neither facility had the raw materials or the appropriate equipment to manufacture chemical weapons, particularly nerve agents or vesicants. Full details are provided in Annex 8.

Interviews

- 8.41 Interviews were held with a total of 39 witnesses, 13 of which were conducted in Damascus. A breakdown of the profiles of the interviewees is given in Table 2.

TABLE 2: PROFILES OF INTERVIEWEES

	Interviewee	Male	Female	Primary Casualty	Secondary Casualty
Treating physician	4	4	0	0	0
Medical support staff	7	6	1	1	0
Witness	28	26	2	9	1
Sampler	0	0	0	0	0
Total	39	36	3	10	1

- 8.42 Of the 39 interviewees, 11 were alleged casualties. Ten of those were alleged primary casualties exposed to a toxic chemical at Location 2, buildings adjacent to Location 2, at the entrance of the vehicle-tunnel of Point One and other locations in the same area, approximately 160 meters south of Location 2 (See Figures 4 and 5). One person purportedly suffered secondary exposure from the bodies of the decedents.

- 8.43 The following is a composite summary of the statements from witnesses interviewed by the FFM team.¹³
- 8.44 A military campaign took place in Douma from approximately 16:00 on Friday, 6 April 2018 until the morning of Sunday 8 April 2018. During this period, witnesses stated that most families gathered to take shelter in the basements of houses and/or buildings across the residential area of Douma. Witnesses stated that 1,000 to 1,500 people were taking shelter at Rif Dimashq Specialized Hospital, also known as Point One (Location 1). Three above-ground floors had been fortified with sand, according to witness statements, allowing the hospital to be used as a shelter.
- 8.45 The medical point was described as being composed of two separate buildings, both consisting of multiple levels. The basement of one building hosted the emergency department and the basement of the other, the surgical department. According to the description of witnesses, vehicles could reach the emergency department through an underground tunnel. The entrance of this tunnel is located approximately 150 meters southwest of Point One and approximately 50 meters east of Location 2. From its entrance, the tunnel extends under Martyrs Square and connects to the emergency department of Point One (see Figure 4). Part of the ground floor of Point One was reported to be used by the SCD for the shrouding of the deceased.
- 8.46 On 7 April, physicians were receiving and treating trauma patients. The hospital was understaffed because many physicians and medical support staff had evacuated to the north a few days earlier. Therefore, on that day, many volunteers were assisting the hospital staff.
- 8.47 Prior to the military campaign, the SCD was in charge of burying the deceased in coordination with the local council. A number of witnesses reported that they were unaware of the location of the burial sites.
- 8.48 Medical staff interviewed by the FFM team members provided their account of events at the hospital on that day. A number of these witnesses reported that there were many fatalities caused by suffocation from dust and rubble as a consequence of the heavy shelling. The number of deaths was exacerbated by the absence of ambulance and rescue services.
- 8.49 Shortly after 19:00, 10 to 20 patients, including children and adults, arrived in groups at the emergency department of Douma Hospital covered in dust and with blackened faces. They had respiratory difficulties that included dyspnoea, coughing and asthmatic exacerbation secondary to exposure to smoke and dust. Staff from other medical points close to Douma hospital also stated that they received casualties with similar signs and symptoms.
- 8.50 A witness reported that he was asked at the emergency department to help hospital staff to wash casualties and, while performing this task, a man who was not from the hospital entered, shouting “Chemical! Chemical!” and panic ensued. Bystanders then began undressing and washing people and proceeded to give inappropriate treatment.

13

The statements from alleged witnesses who came to The Hague (presented in some media, see Annex 2, second bullet point) were dealt with by the FFM as other open-source video material.

- 8.51 The medical staff treated casualties with salbutamol, dexamethasone and oxygen and discharged all casualties by 01:00 on 8 April 2018. On that day, casualties were not registered due to lack of staff.
- 8.52 The witnesses also noted that the heavy shelling resulted in several fires, dust and smoke in Douma. It is also common practice to burn wood, rubber or plastic for heating and cooking inside basements. Some of the medical staff who were interviewed did not hear about the alleged chemical attack from videos circulating on the internet or from other people until a couple of days after the alleged attack on 7 April.
- 8.53 Some witnesses stated that many people died in the hospital on 7 April as result of the heavy shelling and/or suffocation due to inhalation of smoke and dust. As many as 50 bodies were lying on the floor of the emergency department awaiting burial. Others stated that there were no fatalities in Douma Hospital on 7 April and that no bodies were brought to the hospital that day.
- 8.54 A number of the interviewed medical staff who were purportedly present in the emergency department on 7 April emphasised that the presentation of the casualties was not consistent with that expected from a chemical attack. They also reported not having experience in the treatment of casualties of chemical weapons. Some interviewees stated that no odour emanated from the patients, while other witnesses declared that they perceived a smell of smoke on the patients' clothes.
- 8.55 Other medical staff stated that, at around 16:00 on 7 April, an estimated 15 to 18 casualties with difficulty breathing arrived at the SCD Centre located in Sector 3 (see Figure 5). According to the witnesses, an attack with chlorine had taken place in close proximity to this centre (see Figure 5). Other witnesses located at Point One were notified of a chemical attack around the same time by the SCD. No casualties were reported at Point One from this incident. The casualties were washed with water and treated with salbutamol at the SCD Centre.
- 8.56 Shortly after sunset, medical staff members at Point One were notified of an alleged chemical attack. At the emergency department, casualties began arriving shortly after 19:00 with excess salivation or foaming from the mouth, difficulty breathing, coughing, and irritation of the upper respiratory tract. Some casualties were reported to have suffered loss of consciousness. They were reportedly washed by a volunteer, undressed and treated by the medical staff with oxygen, bronchodilators (salbutamol), and intravenous fluids; some were given atropine.
- 8.57 The three bodies that reached Point One on the night of 7 April had profuse foaming from the mouth, pale colour of the skin and a strong odour emanating from their clothes. The 40 bodies taken to Point One on the morning of 8 April arrived in groups, transported by the SCD. They were described as having a blue colour of the skin and foaming from the mouth; some had dust on their clothes. The bodies with a similar odour to those mentioned above were buried later the same day.
- 8.58 Later on, the FFM team members interviewed alleged casualties, first responders and witnesses. The witnesses located in multiple basements used as shelters within a 350 meter distance southwest of Point One stated that at approximately 19:00, while there was still ambient light, the sound of what was described as barrels falling and the

sound of barrels, rockets or projectile impacts were heard. Two of them reportedly did not explode (or the sound of the explosion was mild in comparison to a conventional explosion); and, shortly after, the smell of chlorine was perceived in several basements located within the above-mentioned area.

- 8.59 The smell was described as being similar to cleaning products containing chlorine and local commercial brands, such as “Clor” and “Flash”, were mentioned. They added that the odour was significantly stronger, more pungent and acidic than the cleaning products. Other witnesses described a strong unpleasant smell that was not similar to chlorine and caused shortness of breath, fatigue and blurred vision. The smell of chlorine was also mentioned to be present at Point One around the same time.
- 8.60 Witnesses recounted that, as soon as they perceived the odour, they developed difficulty breathing, eye irritation, severe coughing, nausea, vomiting, weakness, visual impairment, and excess salivation. People located in basements attempted to go upstairs or leave the buildings, despite the intensive shelling. Several witnesses reported covering their mouths and noses with a wet cloth to protect their airways and trying to rescue others. According to witnesses, they self-extricated or were helped by family members and neighbours to go upstairs in search of fresh air, to go outside towards the west where the smell was less intense, or to go to Point One. According to statements, the Red Crescent, SCD and rescuers from the medical point could not respond immediately due to the intense shelling taking place at the time and because rescue vehicles were out of service.
- 8.61 Some witnesses reported seeing a yellow to green cloud or smoke, and one witness described it as a green colour in the atmosphere. This cloud was witnessed on the streets in close proximity to the vehicle entrance of the tunnel leading to the emergency department of Point One and on the ground floor of Location 2.
- 8.62 As reported by witnesses, most casualties who reached the roof or went towards the west, away from Point One, survived. Other casualties who reportedly stayed inside buildings or basements, or who tried to go towards the entrance of the tunnel leading to Point One, died. Witness accounts place the deceased lying on the stairs, inside apartments on multiple levels of Location 2, inside basements of neighbouring buildings across the area, on rooftops and on the streets. Additionally, a witness stated that six casualties died at Point One.
- 8.63 Witnesses stated that the SCD was notified of the incident between 19:30 and 20:00 on 7 April, but was not able to reach Location 2 until shortly after 21:00 due to the intensity of the shelling. The SCD proceeded to rescue survivors and saw many dead bodies inside Location 2 and on the streets. The bodies had copious secretions from the mouth and cyanosis. It was stated that the SCD managed to rescue 20 to 25 casualties from adjacent buildings who were then transported to Point One. Meanwhile, most casualties had self-extricated. The SCD also transported three deceased to Point One but were advised by hospital staff not to bring additional deceased in order to avoid secondary contamination.
- 8.64 According to statements, when the SCD arrived at Location 2, there was a strong and unpleasant odour, similar to chlorine. It was reportedly stronger in the basement and ground floor and they were unable to stay inside for more than few minutes.

- 8.65 Some witnesses reported seeing a yellow cylinder on the terrace of the third floor apartment at Location 2 on the night of 7 April. The presence of a strong odour prevented anyone without respiratory protection from approaching. During the following days, the location was not secured and many had access to the top floor of the building and subsequently to the cylinder itself.
- 8.66 The cylinder was described by witnesses as a yellow “barrel” or “rocket” with dimensions of approximately 1.5 by 0.4 meters. It was lying at an angle, with its nozzle side in the aperture in the floor of the terrace, which corresponds to the ceiling of the room beneath.
- 8.67 Witnesses recounted that the SCD kept bodies inside Location 2 until approximately 9:00 on 8 April, when the shelling ceased. First responders removed the bodies from the building and laid them on the street, in front of the building. The bodies were doused with water and taken to Point One to be prepared for burial. According to several witness reports, the total number of dead from this incident was 43. The total number of casualties was difficult to estimate, as many did not go immediately to the medical point but were washed and assisted elsewhere, either at the Red Crescent facility, the SCD Centre or private residences. Another witness reported 70 patients related to suspected chemical exposure at Point One.
- 8.68 Three casualties stated that another device had landed and released chlorine gas in front of their house approximately 50 to 60 meters from the basement at Location 2. Additionally, several witnesses stated that they perceived the odour of a chemical at different locations within 250 meters southwest of Point One.
- 8.69 At approximately 22:30 on 7 April, first responders were notified of the presence of another yellow cylinder in a residential building (identified as Location 4 by the FFM team) close to the Great Mosque. A witness arrived at this location at approximately midnight on 7 April. The cylinder was on a bed inside a top-floor apartment and a strong odour was described as being similar to chlorine. The witness recounted that there was an aperture in the roof where the cylinder (reportedly 1.5 by 0.5 meter) was thought to have entered the room. The witness stated that the cylinder was leaking gas and that he/she was unable to stay in the room due to the strong odour. Two people were reportedly affected after visiting this location. The alleged casualties stated that they suffered from a burning sensation in the eyes, lacrimation, coughing and vomiting.

EPIDEMIOLOGICAL ANALYSIS

Epidemiological methodology

- 8.70 Epidemiological determination of cause and effect was established according to the following criteria:
- there must be a biologically plausible link between exposure and outcome;
 - there must be a temporal relationship between exposure and outcome; and
 - there must not be any likely alternative explanation for the symptoms.

- 8.71 An epidemiological investigation includes: a review of all the documentation related to an alleged incident; an epidemiological description of the incident; interviews with witnesses, healthcare workers, and first responders; first-hand interviews with survivors; and on-site assessments of symptoms and signs, including assessments of the clinical severity of their syndromes. Further information regarding the treatment and outcomes of persons exposed should be retrieved from medical files relating to the time of the incident and from interviews with the treating clinicians. The epidemiological investigation should yield information about the scale of each event and provide contextual and geographical information that should subsequently be cross-checked and corroborated by the environmental sampling teams [7].
- 8.72 The FFM interviewed four physicians, seven medical support staff and 28 witnesses/casualties.
- 8.73 The FFM could not establish the precise number of casualties; however, some sources¹⁴ reported that it ranged between 70 and 500. Others sources¹⁵ denied the presence of chemically-related casualties.
- 8.74 The number of dead in relation to alleged chemical exposure is reported by a number of witnesses to be 43, distributed between male, female, adults and children.

Medical personnel

- 8.75 Patient admission and treatment records were not maintained during the incident and severity, age and gender details of those casualties that survived were not available at the time of the interviews. Ninety casualties were reported to be admitted (four of which were paediatrics) subsequent to an alleged chemical attack.
- 8.76 Some casualties were described as bearing a non-specific odour on their clothing and were undressed and washed with water prior to entry to Point One.
- 8.77 Detailed physical examinations were not performed due to the number of casualties who were treated and any clinical signs noted were incidental.
- 8.78 According to medical staff accounts, a majority of the casualties were described as having mild signs and symptoms of exposure and were ambulatory. Moderate and severe casualties were non-ambulatory, were described as having altered mental state, and were assisted to the emergency department.
- 8.79 Broadly, patients were reported to display shortness of breath, burning sensation in the chest, oral hypersecretion or foaming, and ocular irritation. Additional complaints were visual disturbances, lacrimation, dysphonia, nausea, vomiting and pruritus. A non-specific number of patients classified as severe manifested with seizure activity described as flexion of arms and wrists. Medical personnel reported the absence of any signs of external trauma.

¹⁴ Paragraphs 8.44 to 8.69.

¹⁵ Paragraphs 8.44 to 8.69.

- 8.80 An unknown number of patients were reported to have manifested either miosis or mydriasis. Although interviewed medical support staff or physicians did not directly observe miosis, one support staff stated that four casualties who were classified as severe were directly observed to be presenting with mydriasis.
- 8.81 Depending on perceived severity, patients were treated with salbutamol via inhaler or nebuliser, corticosteroids and atropine. Treatment with oxygen was sporadic due to limited availability. A non-specific number received treatment with airway adjuncts or endotracheal intubation.
- 8.82 Although some patients received atropine, survived, and were discharged, there was no reported correlation between its administration and clinical improvement associated with its administration in the context of organophosphorus intoxication.
- 8.83 All treatment was reported to be based upon observed signs and symptoms. No diagnostic tests were performed on any casualty. No discharge or patient follow-up information was available at the time of the interviews.
- 8.84 Three deceased persons who were taken to Point One on the night of 7 April were described as having profound oral secretions or foaming, paleness of the skin and a strong, non-specific odour emanating from their clothes.
- 8.85 The 40 deceased persons taken to Point One on the morning of 8 April were transported there in groups by the SCD. They were described as having a blue colour of the skin, oral hypersecretion or foaming; some had dust on their clothes.
- 8.86 The FFM notes that the determination of the severity of signs and symptoms depends on the assessment made by the particular doctor and/or medical support staff and is not necessarily comparable to the determination made by others.

Description of casualties in digital sources

- 8.87 The FFM consulted with four toxicologists and one toxicologist and medical doctor, all versed in chemical weapons or toxic industrial chemical exposure.
- 8.88 Understanding that many of the same sources of information are available online, material reviewed by the FFM was provided to the FFM by casualties, witnesses and medical staff. Only digital information that contained metadata was evaluated for the purposes of this report.
- 8.89 The FFM analysed multiple digital videos and still photographs of alleged victims. The videos and photographs appear to have been taken at Location 1, the SCD Centre; inside Location 2, in the street in front of the building; and at what is reported to be a preparation point for the deceased at Point One (Location 1). The digital videos and still photographs depict both living casualties and decedents. The videos and photos in the building and outside the building appear to have been taken during the night as well as by day. The videos and photos at the medical treatment facility were taken on the night of 7 April 2018.
- 8.90 Videos taken inside Location 2 were recorded between 13 and 16 hours after the reported time of the incident, based on retrieved metadata (Annex 11). They show

approximately 20 people (male, female, adults and children/infants) lying in several rooms (on the floor and furniture) and some lying on top of one another. All the subjects in the video appear dead. One female victim displays corneal opacity. Due to the quality of the videos and the angles of recording, no further ocular signs are noted. Several victims have some degree of thoracic or cervical extension. Many of the victims present with white, foam-like oral and nasal secretions, similar in appearance to fulminate pulmonary oedema but in multiple cases much more profound and seemingly persistent. The secretions are near their mouths, noses and on the floor. Some of the secretions also have an additional light brown colour, which is similar in appearance to gastric contents or blood tinged sputum. When comparing adult and paediatric groups, there does not appear to be any correlation in secretion presence, absence or amount. In one single case, possible urinary incontinence is visible on an adolescent female. No faecal incontinence is noted in any of the victims. Several victims display degrees of periorbital discoloration and early signs of livor mortis. In another video, many of the victims seem to have been moved to one room in the same building; and, in one case, an adolescent male displays obvious signs of rigor mortis. Many of the victims appear to have wet hair in what seems to be an otherwise dry environment. There are no visible signs of external trauma.

- 8.91 Videos taken outside the building during the day were recorded approximately 13 hours after the reported time of the incident, based on retrieved metadata. The video taken outside the building during the night depicts what appear to be four adults lying on the ground in close proximity to an entrance to the building. The daylight video shows many of the same victims who were seen inside the building, as well as others not seen previously, being extracted from the building, doused with water from an SCD firefighting vehicle, and placed in what appears to be civilian vehicles for removal. Some victims cannot be seen, as they are wrapped or covered with carpets or blankets. Those victims who were visible display advanced or complete rigor mortis and have more advanced signs of livor mortis. The video was recorded from a distance of approximately one to five meters and further victim details cannot be clearly seen. There are no visible signs of external trauma.
- 8.92 Still photographs were taken inside and outside the building and at the medical facility. The majority of the photos are of women and children and show facial close ups of the same victims depicted in the videos. Many of the victims exhibit the same airway secretions seen in the videos and, where the faces can be clearly seen, all display corneal opacity and varying degrees of periorbital discoloration. One photo shows a close up of an adult male's face that is covered in what appears to be grey dust or dirt and copious, foam-like airway secretions and blood on his face. There are no further signs of external trauma noted on the victims.
- 8.93 Photos from the medical facility show children being either washed with water or treated with an oxygen mask. None appear to be ill.
- 8.94 A video reportedly taken at the SCD Centre shows a male child, approximately five years of age, who is displaying obvious objective signs of respiratory distress with laboured breathing and accessory muscle use. He is being treated with a small volume nebuliser via mask.

- 8.95 A video taken at the medical treatment facility depicts approximately 20 people (males, females, adults and children) being treated in what appears to be a temporary facility. Some videos contained metadata and were recorded approximately three hours after the reported time of incident. Simple decontamination procedures (washing with water) are carried out on a number of adults and two to three children roughly three to five years of age. Any distress displayed is noted to be mild. There are three young children of approximately 12 to 18 months of age (one male, one female and one of unidentified gender), each of whom is displaying objective signs of respiratory distress manifesting as laboured breathing and accessory muscle use. None appear to be cyanotic. One (male) child is intubated and seen to be receiving manual ventilation and later mechanical ventilation. The other (unidentified gender) child is seated partially upright with an adult and is being treated with a simple oxygen mask. The third (female) child is unresponsive with accessory muscle use, sluggish pupils and miosis estimated to be approximately three millimetres in diameter. She displays no objective signs of hypoxia. Multiple children are seen being treated with an unknown medication via a metered dose inhaler or small volume nebuliser. The adults and remaining children being treated in the video show signs of mild respiratory distress and coughing. No critically ill patients are seen aside from those paediatric patients previously described. There are no visible signs of external trauma.

Analysis of digital information and its relation to toxic chemical exposure

- 8.96 The location, positions and lack of visible trauma on the victims in the videos taken inside the building indicate exposure to a rapidly incapacitating or a highly toxic substance. The victims do not appear to have been in the midst of attempting self-extrication or respiratory protection when they collapsed, indicating a very rapid or instant onset. This type of rapid collapse is indicative of an agent capable of quickly killing or immobilising.
- 8.97 The corneal opacity seen in many of the victims is similar to ocular injuries seen with acid or alkali burns but also resembles post-mortem changes. The interval between death and the time the video/photos were taken is quite broad.
- 8.98 The airway secretions seen in many cases are similar to those seen with exposure to some chemical weapons, toxic industrial chemicals and toxic doses of pharmaceutical agents but are more profound and seem to have a consistency more like viscous foam than secretions typically originating from the upper or lower airways. Notably, there are casualties both with and without secretions that are in very close proximity to one another. In general, the presence and context of the airway secretions indicate exposure to a chemical substance.
- 8.99 The thoracic and cervical extension seen in many of the victims is similar to that seen in those experiencing preterminal full body seizure activity or opisthotonus. Again, this can be seen in deaths resulting from toxic exposure.
- 8.100 Regarding the considerations mentioned in paragraphs 8.98 to 8.100, and in the absence of additional and specific information, the determination of the aetiology from these observations can be related to a wide scope of chemicals [9 – 12].

8.101 The periorbital discoloration is not associated with any specific known toxic exposure. To determine whether it is due to a physiologic response to exposure to a toxic substance or simply post-mortem changes would require additional steps.

8.102 The presentation of wet hair in an otherwise dry environment is difficult to assess and is possibly due to profound diaphoresis shortly before death.

Onset in relation to the allegation

8.103 Many of the signs and symptoms reported by the medical personnel, witnesses and casualties (as well as those seen in multiple videos provided by witnesses), their rapid onset, and the large number of those reportedly affected, indicate exposure to an inhalational irritant or toxic substance. However, based on the information reviewed and with the absence of bio-medical samples from the dead bodies or any autopsy records, it is not currently possible to precisely link the cause of the signs and symptoms to a specific chemical.

9. CONCLUSION OF THE FFM ACTIVITIES

9.1 Based on the levels of chlorinated organic derivatives, detected in several environmental samples gathered at the sites of alleged use of toxic chemicals (Locations 2 and 4), which are not naturally present in the environment, the FFM concludes that the objects from which the samples were taken at both locations had been in contact with one or more substances containing reactive chlorine.

9.2 No organophosphorous nerve agents, their degradation products or synthesis impurities were detected either in environmental samples prioritised for analysis or in plasma samples from alleged casualties.

9.3 Apart from the Schedule 3.B.17 chemical triethanolamine and a Schedule 2.B.04 chemical known as “AmgardV19”, the presence of which was satisfactorily explained,¹⁶ no other scheduled chemicals listed in the Annex on Chemicals to the Chemical Weapons Convention, or their degradation products, were detected in the environmental samples analysed.

9.4 From the analysis of the information gathered during the on-site visits to the warehouse and facility suspected of producing chemical weapons, there was no indication of either facility being involved in their manufacture. The information collected indicates that the activities at both locations were mostly related to the production of explosives.

9.5 Witnesses reported to the FFM team that there were 43 decedents in relation to the alleged chemical incident, most of whom were seen in videos and photos strewn on the floor of multiple levels of an apartment building and in front of the same building. Additionally, several witnesses reported seeing decedents in the basement of the building, on multiple floors of the building, on the streets and inside the basements of several buildings within the same area. A United Nations agency also reported cases

¹⁶

Paragraph 8.7.

of death by exposure to a toxic chemical.¹⁷ However, the team did not have direct access to examine dead bodies, as it could not enter Douma until two weeks after the incident (see paragraph 2.2), by which time the bodies had been buried.

- 9.6 Many of the signs and symptoms reported by the medical personnel, witnesses and casualties (as well as those seen in multiple videos provided by witnesses), their rapid onset, and the large number of those reportedly affected, indicate exposure to an inhalational irritant or toxic substance. However, based on the information reviewed and in the absence of biomedical samples from the dead bodies or any autopsy records, it is currently not possible to precisely link the cause of the signs and symptoms to a specific chemical.
- 9.7 Two yellow industrial cylinders dedicated for pressurised gas with dimensions of approximately 1.4 x 0.4 meters were observed by the FFM team at two separate locations (Locations 2 and 4).¹⁸
- 9.8 The team analysed the available material and consulted independent experts in mechanical engineering, ballistics and metallurgy who utilised specialised computer modelling techniques to provide qualified and competent assessments of the trajectory and damage to the cylinders found at Locations 2 and 4.
- 9.9 The analyses indicated that the structural damage to the rebar-reinforced concrete terrace at Location 2 was caused by an impacting object with a geometrically symmetric shape and sufficient kinetic energy to cause the observed damage. The analyses indicate that the damage observed on the cylinder found on the roof-top terrace, the aperture, the balcony, the surrounding rooms, the rooms underneath and the structure above, is consistent with the creation of the aperture observed in the terrace by the cylinder found in that location.
- 9.10 At Location 4, the results of the studies indicated that the shape of the aperture produced in the modulation matched the shape and damage observed by the team. The studies further indicated that, after passing through the ceiling and impacting the floor at lower speed, the cylinder continued an altered trajectory, until reaching the position in which it was found.
- 9.11 Based on the analysis results of the samples taken by the FFM from the cylinders, their proximity at both locations, as well as the analysis results of the samples mentioned under paragraph 2.6, it is possible that the cylinders were the source of the substances containing reactive chlorine.¹⁹
- 9.12 Regarding the alleged use of toxic chemicals as a weapon on 7 April 2018 in Douma, the Syrian Arab Republic, the evaluation and analysis of all the information gathered by the FFM—witnesses' testimonies, environmental and biomedical samples analysis results, toxicological and ballistic analyses from experts, additional digital information from witnesses—provide reasonable grounds that the use of a toxic

¹⁷ See footnote 6.

¹⁸ The detailed description of the cylinders is present in Annexes 6 and 7.

¹⁹ Paragraphs 8.9 to 8.18.

chemical as a weapon took place. This toxic chemical contained reactive chlorine. The toxic chemical was likely molecular chlorine.

Annexes (English Only):

- Annex 1: Reference Documentation
- Annex 2: Open Sources
- Annex 3: Mission Timelines
- Annex 4: Methodology Details
- Annex 5: Results of Analysis
- Annex 6: Visit to Location 2
- Annex 7: Visit to Location 4
- Annex 8: Visit to the Warehouse and Production Facility
- Annex 9: Evidence Obtained by the FFM
- Annex 10: Documents received from the State Party
- Annex 11: Digital Information Analysis
- Annex 12: Experts Analyses on Industrial Type Cylinders
- Annex 13: Bibliography

Annex 1**REFERENCE DOCUMENTATION**

	Document Reference	Full title of Document
1.	QDOC/INS/SOP/IAU01 (Issue 1, Revision 1)	Standard Operating Procedure for Evidence Collection, Documentation, Chain-of-Custody and Preservation during an Investigation of Alleged Use of Chemical Weapons
2.	QDOC/INS/WI/IAU05 (Issue 1, Revision 2)	Work Instruction for Conducting Interviews during an Investigation of Alleged Use
3.	QDOC/INS/SOP/IAU02 (Issue 1, Revision 0)	Standard Operating Procedure Investigation of Alleged Use (IAU) Operations
4.	QDOC/INS/SOP/GG011 (Issue 1, Revision 0)	Standard Operating Procedure for Managing Inspection Laptops and other Confidentiality Support Materials
5.	QDOC/LAB/SOP/OSA2 (Issue 1, Revision 2)	Standard Operating Procedure for Off-Site Analysis of Authentic Samples
6.	QDOC/LAB/WI/CS01 (Issue 1, Revision 2)	Work Instruction for Handling of Authentic Samples from Inspection Sites and Packing Off-Site Samples at the OPCW Laboratory
7.	QDOC/LAB/WI/OSA3 (Issue 2, Revision 1)	Work Instruction for Chain of Custody and Documentation for OPCW Samples On-Site
8.	QDOC/LAB/WI/OSA4 (Issue 1, Revision 3)	Work Instruction for Packing of Off-Site Samples

Annex 2

OPEN SOURCES

Open source internet links related to the incident in Douma on 07 April 2018

1. Video of alleged victims of alleged chemical attack:
<https://edition.cnn.com/2018/04/07/middleeast/syria-suspected-chemical-attack/index.html>
2. Press conference by The Russian Federation Delegation, held at OPCW HQ in presence of alleged witnesses: <https://www.youtube.com/watch?v=FF9KPKK2ARc>
3. Online Article regarding Douma: <http://www.heraldsun.com.au/news/breaking-news/syria-denies-chemical-attacks-on-douma/news-story/ddd7bfdc568594195f594f653ecab59f>
4. Video of alleged casualties and victims: <https://www.aljazeera.com/news/2018/04/suspected-chemical-attack-kills-dozens-syria-douma-180407202906316.html>
5. Video of alleged victims at Location 2: <https://youtu.be/m4lkf1SNcJI>
6. Video of alleged casualties at hospital: https://youtu.be/KpwcV0sup_o
7. Video of alleged victims at Location 2: <https://youtu.be/8TElceE3aLI>
8. Video of alleged victims at Location 2:
<https://twitter.com/inegazili/status/982850611665428480>
9. Tweet of photos of alleged victims at Location 2:
https://twitter.com/Common_Mohammad/status/982854571952431104
10. Tweet of photos of alleged casualties:
<https://twitter.com/KokachOmar/status/982851902223286272>
11. Tweet of photos of alleged casualties:
<https://twitter.com/KokachOmar/status/982851294154108929>
12. Video of alleged casualties at hospital: <https://youtu.be/-VmQs8786Q8>
13. Tweet of photos of alleged casualties and victims:
https://twitter.com/Charles_Lister/status/982714880154365952
14. Online Article about conflict in Douma: <https://www.aljazeera.com/news/2018/04/syrian-forces-press-offensive-rebel-held-douma-180407135235699.html>
15. Facebook post about Douma:
https://m.facebook.com/story.php?story_fbid=1739236919490549&id=111632495584341&refid=52&_tn_=-R
16. Tweet regarding alleged victims at Location 2:
<https://twitter.com/SyriaCivilDef/status/982623580180635648>
17. Tweet of photos of alleged casualties:
<https://twitter.com/talentosprecato/status/982619592458752001>

Open source internet links related to the incident in Douma on 07 April 2018

18. Tweet about alleged attack in Douma:
<https://twitter.com/Elizrael/status/982640972218675202>
19. Tweet of photos of alleged casualties:
<https://twitter.com/SiegeUpdates/status/982630326387335170>
20. Tweet of photos of alleged casualties:
<https://twitter.com/FSAPlatfrom/status/982627437082218496>
21. Tweet about alleged chemical attack:
<https://twitter.com/HusamHezaber/status/982626159518277633>
22. Video about alleged casualties at hospital: <http://www.bbc.com/news/world-middle-east-43686157>
23. Online Article regarding alleged chemical attack: https://www.sams-usa.net/press_release/sams-syria-civil-defense-condemn-chemical-attack-douma/
24. Online Article regarding alleged chemical attack: <http://www.syriahr.com/en/?p=88799>
25. Tweet of SCD statement: <https://twitter.com/SyriaCivilDef/status/982976756163514368>
26. Online Article regarding alleged evacuation of Douma: <https://www.reuters.com/article/us-mideast-crisis-syria-deals/hostages-and-rebels-leave-douma-under-evacuation-deal-state-media-idUSKBN1HF0XO>
27. Online Article regarding alleged evacuation of Douma : <https://www.reuters.com/article/us-mideast-crisis-syria-ghouta-negotiati/rebel-fighters-begin-leaving-syrias-douma-after-weeks-long-military-assault-idUSKBN1HF09Z>
28. Tweet of video at Location 4: <https://twitter.com/AsaadHannaa/status/982998575222312961>
29. Online Article regarding alleged evacuation of Douma : <http://www.syriahr.com/en/?p=88870>
30. Video of alleged victims: <https://www.youtube.com/watch?v=PIyGJugmGaI>
31. Video of alleged victims: <https://www.youtube.com/watch?v=8TElceE3aLI>
32. Video of alleged victims at Location 2: <https://www.youtube.com/watch?v=LozZIXcYQ9c>
33. Video of interview: <https://www.youtube.com/watch?v=6F5ZNF8MDIA>
34. Video of alleged casualties, video of 11 year old boy:
<https://www.youtube.com/watch?v=JPFaEG9vJT4>
35. Video of alleged victims at Location 2:
<https://www.youtube.com/watch?v=2mw8DZEiSR0&feature=youtube.be>
36. Online Article regarding alleged chemical attack in Douma:
<https://www.bellingcat.com/news/mena/2018/04/11/open-source-survey-alleged-chemical->

Open source internet links related to the incident in Douma on 07 April 2018

[attacks-douma-7th-april-2018/](#)

37. Video regarding alleged production facility:
<https://sputniknews.com/middleeast/201804201063754094-russia-syria-douma-militants-lab/>
38. Video of alleged victims at Location 2:
https://www.youtube.com/watch?v=t99NFijj4Pg&oref=https%3A%2F%2Fwww.youtube.com%2Fwatch%3Fv%3Dt99NFijj4Pg&has_verified=1
39. Video of alleged victims at Location 2:
https://www.youtube.com/watch?v=DfQiFEyin_4&oref=https%3A%2F%2Fwww.youtube.com%2Fwatch%3Fv%3DDfQiFEyin_4&has_verified=1
40. Video of alleged victims at Location 2:
https://www.youtube.com/watch?v=0K9H8dh12uE&oref=https%3A%2F%2Fwww.youtube.com%2Fwatch%3Fv%3D0K9H8dh12uE&has_verified=1
41. Video of alleged victims at Location 2:
https://www.youtube.com/watch?v=ajpjrYSOoYM&oref=https%3A%2F%2Fwww.youtube.com%2Fwatch%3Fv%3DajpjrYSOoYM&has_verified=1
42. Online Article regarding alleged chemical attack in Douma: https://smartnews-agency.com/images/videos/2018/04/08/VNC-SY-180408-286/clip.mp4_1080.mp4

Annex 3**MISSION TIMELINE**

Date	Activities
7 April	Reports of alleged chemical attack in Douma, Syrian Arab Republic. TS Infocell begins immediate collection of open source materials to assess credibility of the allegation.
10 April	Technical Secretariat requests the Syrian Arab Republic, through Note Verbale (NV/ODG/214589), to provide any information it might have regarding the allegation of use of chemical weapons on 7 April 2018 in Douma.
10 April	Permanent Mission of the Syrian Arab Republic requests, through Note Verbale No. 38, that a Fact-Finding Mission be dispatched urgently to visit the city of Douma to verify the information surrounding the alleged use of toxic chemicals on 7 April 2018.
10 April	Permanent Representative of the Russian Federation submits a letter to the OPCW welcoming the request from the Syrian Arab Republic and pledges to facilitate the mission.
10 April	Technical Secretariat informs the Syrian Arab Republic in Note Verbale (NV/ODG/214589) of the intention to deploy an advance team of the OPCW FFM to Damascus on Thursday 12 April 2018.
10 April	Technical Secretariat informs the Syrian Arab Republic in Note Verbale (NV/ODG/214603/18) of its intention to deploy the remaining Team to Damascus on Friday 13 April.
12 April	Advance team arrives in a neighbouring country.
13 April	Advance team discusses logistic arrangements with UNOPS in neighbouring country.
13 April	Advance team joined by the follow-on team.
14 April	Team preparations and meetings in neighbouring country.
14 April	FFM departs for Damascus.
14 April	FFM meets with SP representatives for mandate handover, preliminary security discussions and submission of prepared list of questions and requests.

Date	Activities
15 April	Written communication (FFM/05018-DOC 02) from the Director General through the FFM to Syrian Arab Republic representatives conveying his request for the Syrian Arab Republic to expedite security arrangements to facilitate the FFM activities.
15 April – 12 May	34 interviews conducted by FFM, including 13 in Damascus.
16 April	Second element of the FFM deploys from headquarters to conduct further interviews and sampling activities.
16 April	Note Verbale (NV/ODG/18) from TS to the Permanent Representative of the Syrian Arab Republic to the OPCW accepting the Syrian Arab Republic proposal that the MP from the Russian Federation present in Douma provide a security escort to the FFM, from the point of entry to the final point of exit to the sites relevant to the mandate of the FFM.
16 April	Meeting among members of FFM, UNOPS, UNDSS, and representatives of the Syrian Arab Republic and Russian military personnel to discuss security arrangements. First deployment agreed for 18 April.
17 April	A UNDSS team, accompanied by Russian MP, conducts a reconnaissance mission to Locations 1 and 2 to assess security for the proposed deployment on 18 April.
17 April	Security incident during the reconnaissance mission, involving use of light arms and hand-grenade explosion, requiring rapid exit of the reconnaissance team from target site at Location 2.
17 April	Team Leader (TL) redeployed for information gathering activities from all other available sources. Deputy TL takes over leadership in Damascus.
18 April	FFM receives environmental and biomedical samples from witnesses.
18 April	Meeting between representatives of the Syrian Arab Republic, Russian military personnel, the FFM, UNOPS, and UNDSS to discuss security situation in Douma, in particular the security related to the 17 April incident.
18 April	FFM received written reply to the questions and requests submitted to the Syrian Arab Republic on 15 April.
19 April	UNDSS and OMS representatives approach the team with a proposal to conduct reconnaissance at Location 1 (hospital) on 19 April, with the possibility of deploying a reduced team to the same location on 20 April 2018. Due to the priorities set by the FFM, the proposal is not further explored.

Date	Activities
19 April	FFM requests advice from HQ on legal implications of collecting privately owned items for evidence purposes.
20 April	Note Verbale (NV/ODG/214771/18) from TS to the Permanent Representative of the Syrian Arab Republic to the OPCW regarding the rights of the FFM with regard to collecting items of personal property as evidence for the investigation.
20 April	Note Verbale from the Syrian Arab Republic to the Director General of the OPCW requesting him to instruct the FFM to conduct a visit to a warehouse containing chemicals and equipment, within the framework of the FFM's mandate, to collect information surrounding the allegation of use of toxic chemical substances in the city of Douma in Rif Dimashq on 7 April 2018.
20 April	Reconnaissance mission to Location 2 by UNDSS escorted by Russian MP.
21 April	FFM receives environmental and biomedical samples.
21 April	FFM deploys to Location 2. Team collects samples, takes photos and conducts physical measurements.
22 April	FFM receives environmental samples from a witness.
22 April	First FFM progress report submitted to the Director General on the activities conducted from 14-21 April 2018.
23 April	Receipt of written reply to the request of the FFM for information on any activities by Russian military personnel at Location 2 since the alleged incident.
23 April	Photos of seals on samples taken at Location 2 given to the Syrian Arab Republic.
23 April	Team informed of TS approval to deploy to Location 4 as next priority and instructed to also visit the warehouse referred to in the NV from the Syrian Arab Republic.
23 April	FFM meets with UNDSS, UNOPS, the Syrian Arab Republic and Russian Federation military representatives to agree security arrangements for deployment to Location 4.
24 April	Reconnaissance of Location 4 by UNDSS escorted by Russian MP and approval from HQ for the FFM to deploy.
25 April	FFM deploys to Location 4, collects samples, takes photos, and conducts physical measurements.

Date	Activities
25 April	Second FFM progress report submitted to the Director General
26 April	Note Verbale (NV/ODG/214827/18) from the Secretariat to the Permanent Representative of the Syrian Arab Republic to the OPCW, requesting information and assistance from the Government of the SAR in getting the FFM access to the remains of any interred persons whose death might have been associated with the alleged incident on 7 April, including the exhumation of human remains.
26 April	Note Verbale (NV/ODG/214836/18) from the TS to the Permanent Representative of the SAR to the OPCW, requesting that the SAR transport the cylinders observed at Locations 2 and 4 to a secure location for packing and facilitate the application of OPCW seals by the FFM for possible future evaluation by the Secretariat.
27 April	FFM visits the warehouse, collects samples, takes photos and conducts physical measurements.
27 April	Third FFM progress report submitted to the Director General
30 April	FFM deploys to the facility suspected of producing chemical weapons, collects samples, takes photos, and conducts physical measurements. A SAR representative informs the FFM that no decision has been made regarding the sealing of the cylinders.
30 April	Fourth FFM progress report submitted to the Director General
1 May	FFM visits Location 1 (hospital) and revisits Location 4 (takes photos and physical measurements). A SAR representative informs the TL that SAR Government will not accept the sealing of the cylinders.
2 May	FFM departs from Damascus.
3 May	FFM returns to OPCW headquarters.
4 May	Secretariat receives Note Verbale (No. 44) replying to TS request to seal the cylinders in Note Verbale NV/ODG/214836/18
4 May	Secretariat receives Note Verbale (No. 45) from the SAR replying to the Technical Secretariat's request in Note Verbale (NV/ODG/214827/18) to exhume bodies for the purpose of taking bio samples.

Date	Activities
9 - 15 May	FFM redeploys to conduct interviews.
24 May	FFM delivers fractions of samples to the SAR.
3 June	FFM tags and seals cylinders from Locations 2 and 4. The procedure is documented.
6 July	Interim Report issued by the Secretariat (S/1645/2018).
7 August	Secretariat receives Note Verbale (No. 60) from the SAR: Remarks of the Syrian Arab Republic on the FFM Interim Report on Douma Alleged Incident.
September	Consultations with toxicologists.
14 - 22 October	FFM redeploys to conduct interviews.
October	Consultations with toxicologists and engineering experts.
November	Consultations with engineering experts.
December	Reception of engineering studies.
8 February 2019	FFM receives lab results for the second batch of samples.

Annex 4

METHODOLOGY DETAILS

SAMPLING

Sample types

1. Sampling was considered a key source of primary evidence in assessing whether toxic chemicals had been used as a weapon on 7 April 2018 in Douma. Given that the FFM team would potentially have direct access to alleged incident sites and would therefore be able to select and collect samples, very careful and meticulous consideration was given to selecting sample types as per OPCW procedures, particularly in relation to samples that would be of the greatest potential probative value. To the greatest extent possible, the selection was founded on scientific rationale, ideally backed by proven scientific experience or peer-reviewed literature.
2. *Sampling for chlorine or chlorine derivatives:* Chlorine is a volatile gas that is two and a half times heavier than air. It is unstable both in the environment and *in vivo*, and generates decomposition products which are also very reactive or non-specific. Once released to the environment chlorine rapidly reacts with water or atmospheric moisture, generating hydrochloric acid and hypochlorous acid [14] [15]. Similarly, when chlorine comes in contact with moisture in nasal, trachial, and lung tissue, the chlorine disproportionates to the same acids [16]. Moreover, chlorine gas rapidly degrades with ultraviolet radiation, generating chlorine free radicles in daylight [12]. For that reason, detecting chlorine gas *per se* in the environment or in body tissue or fluids following exposure is highly unlikely, particularly if there is a significant delay in collecting the samples, as in this particular case.
3. Although chlorine decomposes rapidly in the environment, the gas itself or its decomposition products are known to react with a variety of other chemicals in the environment, including organic materials and metals [15] [17] [18] [19] [20]. Such products can be quite stable and therefore could provide long-lived chemical signatures of chlorine exposure. The possibility of finding such chlorine derivatives guided the FFM team in its selection of sample types as a means of indirectly demonstrating with a high level of confidence that chlorine gas, or at least a substance containing reactive chlorine, had been present in the environment of the alleged incident.
4. Just as chlorine or its decomposition product hypochlorous acid interacts with alkene moieties of inanimate organic matter, similar interactions can take place with biological materials. Although biomarkers that specifically indicate chlorine exposure remain unclear a limited number of biomarker studies for chlorine involving animal and human exposure have been published. They include studies on chlorinated derivatives of surfactant proteins in lung tissue, chlorotyrosines and phosphatidylglycerol chlorohydrins [21] [22] [23] [24] [25] [26]. While all of these chlorinated derivatives provide promising possibilities for detecting human or animal exposure to chlorine gas, reports indicate that, *in vivo*, they are relative short-lived

biomarkers, with levels returning to baseline within periods ranging from 24 to 72 hours post-exposure.

5. Other studies have been conducted where markers for chlorine exposure have been detected up to periods of 7-10 days post-exposure [27]. The studies relate to the effects of chlorine on Clara cell secretory proteins in which chlorine exposure results in sloughing of Clara cells from tracheal epithelium.
6. Human hair was considered another relevant sample type as evidence for possible exposure to chlorine [28]. The interaction of chlorine with proteins such as cysteine and keratin in hair has been well studied.
7. Although molecular chlorine is not naturally present in the environment, chloride ions and many chlorinated organic derivatives exist in the natural background. For that reason it was important to gather control samples, wherever feasible, at locations not expected to have been exposed to chlorine gas.

PHYSICAL DATA COLLECTION

8. As with sampling, pre-deployment plans were developed to identify key measurements and photos to be taken during the visits to the various locations.

Annex 5

RESULTS OF ANALYSIS

TABLE A5.1: ENVIRONMENTAL SAMPLES RECEIVED OR COLLECTED BY THE FACT-FINDING MISSION

Samples collected from Location 2							
Entry #	Sample Code	Description	Evidence Reference Number	DL02 code	Results DL02	DL 03 code	Results DL03
1.	10WPS	Swab from inside the cylinder orifice (level 3)	20180421190910	D	No chemicals relevant to Convention have been found.	E10	No CWC-scheduled chemicals detected.
2.	11WPS	Swab with water from inside the cylinder orifice (level 3)	20180421190911	E	Dichloroacetic acid, chloride.	E11	No CWC-scheduled chemicals detected.
3.	15WPS	Dry wipe of the cylinder thread (level 3)	20180421190915	A	Dichloroacetic acid	WP15	No CWC-scheduled chemicals detected [1], chloride: 13,000 ppm (IC), iron: 11 ppm (ICP-MS), manganese: 36 ppm (ICP-MS), zinc: 10,000 ppm (ICP-MS)
4.	19SLS	Concrete debris from the crater-edge in front of the cylinder nose (level 3)	20180421190919	F	Dichloroacetic acid, trichloroacetic acid, chloral hydrate, trichlorophenol.	C19	No CWC-scheduled chemicals detected. 2,4,6-trinitrotoluene*.
5.	21WPS	Wipe with water from the burnt wall in the room located under the cylinder (level 2)	20180421190921	B	No chemicals relevant to CWC have been found.	WA21	No CWC-scheduled chemicals detected [1], CLOC (trace, LC-HRMS)

Samples collected from Location 2							
Entry #	Sample Code	Description	Evidence Reference Number	DL02 code	Results DL02	DL 03 code	Results DL03
6.	22WPS	Wipe with DCM from burnt wall from room under the cylinder (level 2)	20180421190922	C	No chemicals relevant to CWC have been found.	WD22	No CWC-scheduled chemicals detected [1], CLOC (trace, GC)
7.	25SDS	Wood fragment from kitchen door (level 2)	20180421190925	G	Dichloroacetic acid, trichloroacetic acid, chlorophenol.	V25	No CWC-scheduled chemicals detected. phenol, 2,4,6-trichlorophenol†, 2,4,6-trinitrotoluene*.
8.	24WPS	Dry wipe from kitchen wall above the oven (level 2)	20180421190924	D	No chemicals relevant to CWC have been found.	WP24	No CWC-scheduled chemicals detected [1], CLOC (trace, LC-HRMS) chloride: 1,100 ppm (IC), iron: 1.2 ppm (ICP-MS), manganese: 0.4 ppm (ICP-MS), zinc: 1.7 ppm (ICP-MS)
9.	01SLS	Concrete debris from the street, left side below window (level 0)	20180421190901	B	Dichloroacetic acid, trichloroacetic acid, chlorophenol, trinitrotoluene*.	C01	No CWC-scheduled chemicals detected, 2,4,6-Trinitrotoluene*.
10.	03SLS	Concrete debris from the middle of street opposite to the window (level 0)	20180421190903	C	Dichloroacetic acid, trichloroacetic acid, chlorophenol, dichlorophenol, trinitrotoluene*.	C03	No CWC-scheduled chemicals detected. 2,4,6-Trinitrotoluene*.
11.	35AQS	Water from water tank in basement (level -1)	20180421190935	K	No chemicals relevant to CWC have been found.	W35	No CWC-scheduled chemicals detected.

Samples collected from Location 2							
Entry #	Sample Code	Description	Evidence Reference Number	DL02 code	Results DL02	DL 03 code	Results DL03
12.	32SDS	Water tank wood support in basement (level -1)	20180421190932	I	Dichloroacetic acid, trichloroacetic acid.	V32	No CWC-scheduled chemicals detected. alpha-pinene, bornyl chloride [†] , phenol, 2,4,6-trichlorophenol [†] , 2,4,6-trinitrotoluene*.
13.	30WPS	Dry wipe from bicycle rear cassette in basement (level -1)	20180421190930	H	No chemicals relevant to CWC have been found.	S30	No CWC-scheduled chemicals detected.
14.	34SDS	Wood from partition frame in basement (level -1)	20180421190934	J	Dichloroacetic acid, trichloroacetic acid.	V34	No CWC-scheduled chemicals detected. phenol, 2,4,6-trichlorophenol [†] , 2,4,6-trinitrotoluene*.
15.	38WPS	Swab with water from electric socket basement (level -1)	20180421190938	F	No chemicals relevant to CWC have been found.	WA38	No CWC-scheduled chemicals detected [1]
16.	43WPS	Wipe with water from lavatory extractor pipe in basement (level -1)	20180421190943	G	No chemicals relevant to CWC have been found.	WA43	No CWC-scheduled chemicals detected [1]

* TNT = Explosive, [1] CWC-scheduled chemicals and degradation products (estimated detection limit: <100 ppb).

CLOC = Chlorine containing Organic Chemicals, [†]Chlorinated compounds from wood.

Samples collected from Location 4							
Entry #	Sample Code	Description	Evidence Reference Number	DL02 code	Results DL02	DL 03 code	Results DL03
17.	11WPS-L4	Dry wipe from nozzle, front part next to thread	20180425178811	H	Trichloroacetic acid, 1-methyl-2,4,6-trinitrobenzene*	WP11	No CWC-scheduled chemicals detected [1], chloride: 15,000 ppm (IC), iron: 390 ppm (ICP-MS), manganese: 54 ppm (ICP-MS), zinc: 4,700 ppm (ICP-MS)
18.	17WPS-L4	Wipe with DCM of cylinder nozzle	20180425178817	K	No chemicals relevant to CWC have been found.	WD17	No CWC-scheduled chemicals detected [1], CLOC (trace, GC), 2,4,6-trinitrotoluene* (ultra-trace, LC-HRMS, GC)
19.	16WPS-L4	Wipe with DCM from headbed	20180425178816	J	No chemicals relevant to CWC have been found.	WD16	No CWC-scheduled chemicals detected [1], CLOC (trace, GC), 2,4,6-trinitrotoluene* (trace, LC-HRMS, GC)
20.	04SDS-L4	Blanket under cylinder	20180425178804	L	Dichloroacetic acid, trichloroacetic acid, chloral hydrate, trichlorophenol, trinitrotoluene*, chloride.	TL4	No CWC-scheduled chemicals detected. * 2,4,6-trinitrotoluene .

Samples collected from Location 4							
Entry #	Sample Code	Description	Evidence Reference Number	DL02 code	Results DL02	DL03 code	Results DL03
21.	10SDS-L4	Pillow cover on the bed , closer to the wall	20180425178810	N	Dichloroacetic acid, trichloroacetic acid, trichlorophenol, tetrachlorophenol, chloral hydrate, trinitrotoluene [*] , chloride.	T10	No CWC-scheduled chemicals detected. 2,4,6-trinitrotoluene [*] .
22.	06SDS-L4	Wet wood from under the cylinder	20180425178806	M	Bornyl chloride [†] , chloride.	V06	No CWC-scheduled chemicals detected. alpha-pinene, bornyl chloride [†] , phenol, 2,4,6-trichlorophenol [†] ,
23.	13WPS-L4	Dry wipe from stains on the wall, behind the bed	20180425178813	O	No chemicals relevant to CWC have been found.	S13	No CWC-scheduled chemicals detected. 2,4,6-Trinitrotoluene [*] .
24.	14SDS-L4	Chips of paint from wall behind bed. Reading on LCD 3.3: GB,HD,VXR	20180425178814	I	Tetrachlorophenol, 1-methyl-2,4,6-trinitrobenzene*, amino dinitrotoluene ^Δ , (isomer not specified)	SS14	No CWC-scheduled chemicals detected [1]. CLOC (trace, LC-HRMS), chloride: 2,600 ppm (IC), zinc: 150 ppm (ICP-MS)
25.	19SDS-L4	Gloves from stairs	20180425178819	L	Dichloroacetic acid, trichloroacetic acid, 1-methyl-2,4,6-trinitrobenzene*, amino dinitrotoluene ^Δ , Permethrin [∞]	SS19	No CWC-scheduled chemicals detected [1] CLOC (trace, LC-HRMS) chloride: 17,000 ppm (IC) zinc: 1,500 ppm (ICP-MS)

* TNT = Explosive, [1] CWC-scheduled chemicals and degradation products (estimated detection limit: <100 ppb).

∞ Chlorine containing Organic Chemicals, † Chlorinated compounds from wood.

Samples collected from Hospital							
Entry #	Sample Code	Description	Evidence Reference Number	DL02 code	Results DL02	DL 03 code	Results DL03
26.	S6	Concrete dust 5-13 on right hand side at wall	20180501177906	N	Trichlorophenol (isomer not specified) tetrachlorophenol, Permethrin [∞] , Malathion [∞] , Deltamethrin [∞] , Linuron [∞] , 1-methyl-2,4,6-trinitrobenzene*, amino dinitrotoluene ^Δ (isomer not specified)	SS06	No CWC-scheduled chemicals detected [1] CLOC (trace, LC-HRMS) chloride: 830 ppm (IC) 2,4,6-trinitrotoluene* (ultra-trace, LC-HRMS, GC)
27.	S7	Grouting from 5-13 c. 1 m out from LHS wall	20180501177907	Q	No chemicals relevant to CW have been found.	C07	No nerve agent related chemicals detected. triethanolamine [‡]

* TNT = Explosive, [1] CWC-scheduled chemicals and degradation products (estimated detection limit: <100 ppb). ‡Surfactant for textiles
CLOC = Chlorine containing Organic Chemicals, [∞]Pesticide, ^ΔPrecursor of TNT

Sample collected from Alleged Production Facility							
Entry #	Sample Code	Description	Evidence Reference Number	DL02 code	Results DL02	DL 03 code	Results DL03
28.	04WPS-PF	Swab sample with water from outlet valve on reactor	20180430150804	P	No chemicals relevant to CWC have been found.	E04	No CWC-scheduled chemicals detected.

Sample collected from Warehouse							
Entry #	Sample Code	Description	Evidence Reference Number	DL02 code	Results DL02	DL 03 code	Results DL03
29.	41BSS-WH	Solid sample from white bag with Cheminol label and labelled as hexamine	20180427191404	M	1,3,5,7-Tetraazatricyclo[3.3.1.1 ^{3,7}]decane or hexamine	SS41	No CWC-scheduled chemicals detected [1] hexamine (high purity, LC-HRMS, GC, NMR)
Samples received from witnesses							
Entry #	Sample Code	Description	Evidence Reference Number	DL02 code	Results DL02	DL 03 code	Results DL03
30.	FFM-49-18-SDS05	Pieces of timber	20180421178220	T	No chemicals relevant to CWC have been found.	V05	No CWC-scheduled chemicals detected. phenol, 2,4,6-trichlorophenol [†] , 2,4,6-trinitrotoluene [*] .
31.	FFM-49-18-SDS07	Scarf collected from the basement	20180422174805	U	No chemicals relevant to CWC have been found.	T07	No nerve agent chemicals detected. triethanolamine [‡] , "AmgardV19" phosphonate [♦] , malathion [∞] , 2,4,6-trinitrotoluene [*] .
32.	FFM-49-18-SDS08	Toy stuffed animal collected from basement	20180422174804	V	No chemicals relevant to CWC have been found.	T08	No nerve agent chemicals detected. triethanolamine [‡] , 2,4,6-trinitrotoluene [*] .

Samples received from witnesses							
Entry #	Sample Code	Description	Evidence Reference Number	DL02 code	Results DL02	DL 03 code	Results DL03
33.	FFM-49-18-SDS04	Piece of clothes from victim	20180421178219	S	Dichloroacetic acid, trichloroacetic acid, dichlorophenol, trichlorophenol.	T04	No nerve agent related chemicals detected. triethanolamine [†] , 2,4,6-trinitrotoluene . [*]

* TNT = Explosive, [1] CWC-scheduled chemicals and degradation products (estimated detection limit: <100 ppb).

† Chlorinated compounds from wood.

‡ Surfactant for textiles.

◆ Flame retardant for polyester textiles. ^oPesticide

TABLE A5.2: BIOMEDICAL SAMPLES RECEIVED OR COLLECTED BY THE FACT-FINDING MISSION

Biological samples were sent on the first group to Designated Laboratories										
Entry number	Sample Code	Description	Evidence Reference Number	DL 02 code	Results DL02	DL 03 code	Results DL03			
1.	178201	Plasma	20180421178201	A	No relevant chemicals found	A				
2.	178204	Plasma	20180421178204	B	No relevant chemicals found	B				
3.	178207	Plasma	20180421178207	C	No relevant chemicals found	C				
4.	178210	Plasma	20180421178210	D	No relevant chemicals found	D				
5.	178213	Plasma	20180421178213	E	No relevant chemicals found	E				
6.	175704 A	Plasma	20180418175704A	F	Sample was not analysed	F				
7.	175703 A	Plasma	20180418175703A	G	Sample was not analysed	G				
8.	1748PL	Plasma	201804211748PL	H	No relevant chemicals found	H				
9.	1753PL	Plasma	201804251753PL	I	No relevant chemicals found	I				
10.	1770PL	Plasma	201804211770PL	J	No relevant chemicals found	J				
11.	1795PL	Plasma	201804211795PL	K	No relevant chemicals found	K				

* BChE = butyrylcholinesterase

Nerve agent adducts of BChE* derived nonapeptide (G- and V-type agents):
No compound found.

Aged G agent adduct of BChE-derived nonapeptide:
No compound found.

Nerve agent adduct of tyrosine (G- and V-type agents):
No compound found.

Annex 6

VISIT TO LOCATION 2

Visit to Location 2 (“Cylinder on the Roof”)

1. In light of the security incident that occurred during the reconnaissance visit to Location 2 on 17 April, a tarpaulin was placed during the second reconnaissance visit on 20 April, across the exposed north-facing end of the roof terrace to minimise the exposure of the FFM team to potential sniper fire from adjacent buildings while conducting investigation activities. The team also had to exercise special precautions when working on the terrace given the uncertainty of its structural integrity as a result of the aperture that had been created allegedly by the falling cylinder.
2. Selected photos taken by the FFM of the terrace, crater, cylinder, and room beneath are shown below.²⁰

FIGURE A.6.1 PHOTOS OF TERRACE, CRATER, AND ROOM BENEATH



²⁰

Refer to Paragraph 8.23.



3. The aperture observed was circular in shape with approximately 45 degrees angular edges.
4. The mangled ironwork present on the patio indicated that there would have been a metallic frame and mesh covering it at one stage, though it was not clear whether this would have been present at the time of the alleged incident or had been demolished prior to that. The visual damage on the body of the cylinder indicates that the lateral aspect of the cylinder did not slide on the mesh but it hit perpendicularly.

FIGURE A.6.2 CYLINDER WITH VISIBLE DAMAGE LIKELY ORIGINATING FROM THE MESH



5. The FFM team noted that a similar crater (see photos below) was present on a nearby building.

FIGURE A.6.3 ADJACENT ROOF SHOWING A CRATER SIMILAR TO THE ONE ON THE ROOF TERRACE AT LOCATION 2



6. The team was not able to climb on to the top of the building due to the security restrictions, but was able to observe damage in the corner of the balcony location above the crater.

FIGURE A.6.4 DAMAGE ABOVE THE CRATER OBSERVED FROM DIFFERENT ANGLES



7. Observing the damage on the roof above the crater, the experts were able to provide an explanation of the cylinder not penetrating completely through the aperture. It can be seen that there was a large impact on the roof and walls above the balcony. The impact would decrease the velocity of the falling cylinder and changed its trajectory while hitting the concrete floor of the balcony causing a hole in it, but without sufficient energy to fall through it.

FIGURE A.6.5 DAMAGE OBSERVED ON THE CYLINDER

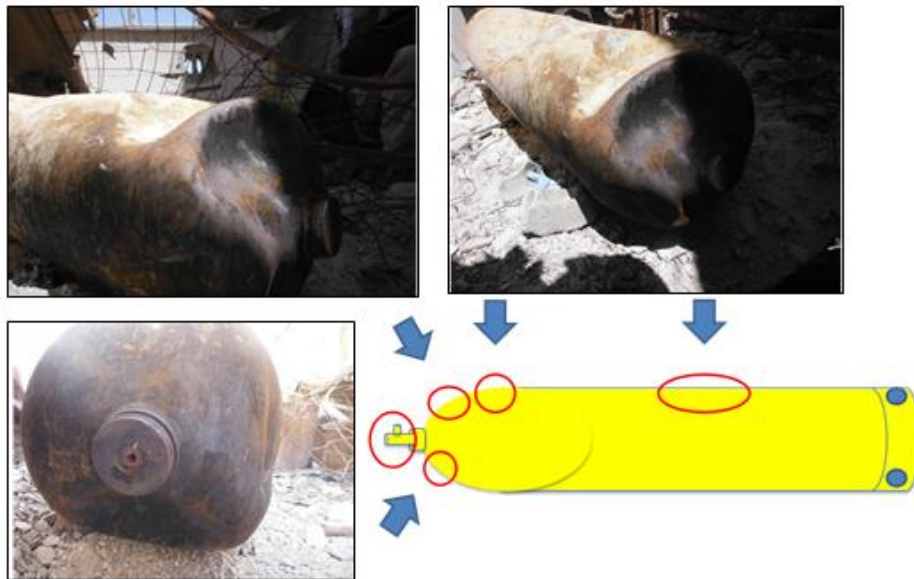
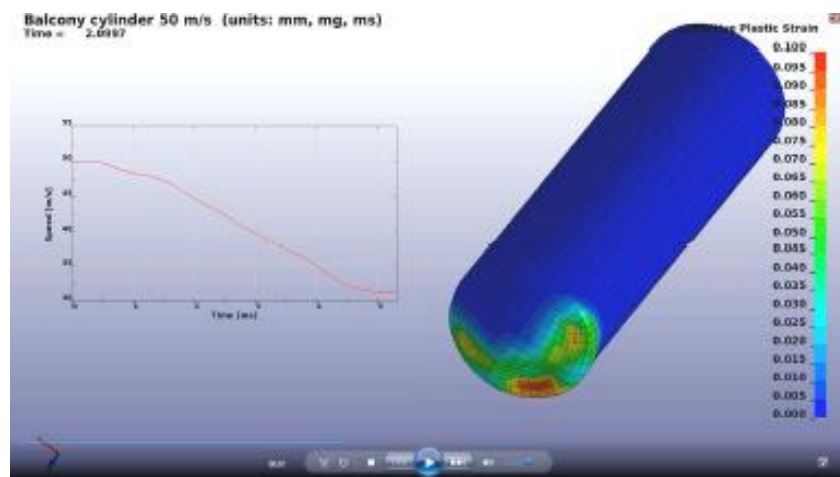

FIGURE A.6.6 CYLINDER FRONT END DEFORMATION IF IMPACTED WITH THE CORNER ON THE ROOF ABOVE THE BALCONY²¹



²¹ The angle shown in figures A.6.6, A.6.7 (a) to (c) are indicative only and not representing actual impact angle.

FIGURE A.6.7(a) MODULATION OF CYLINDER IMPACT ON BALCONY CEILING

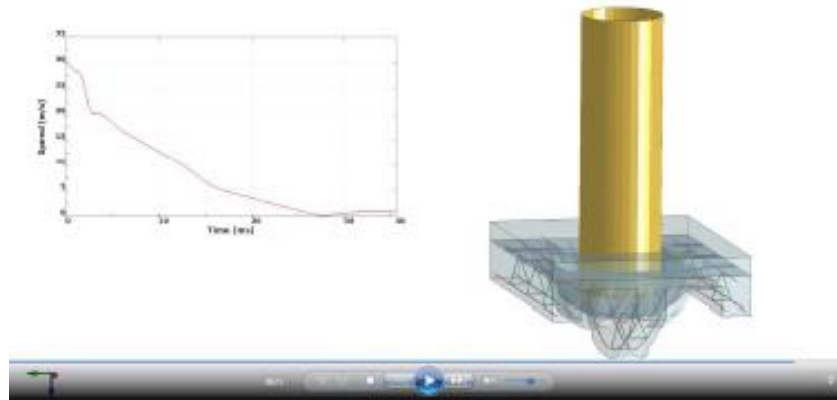
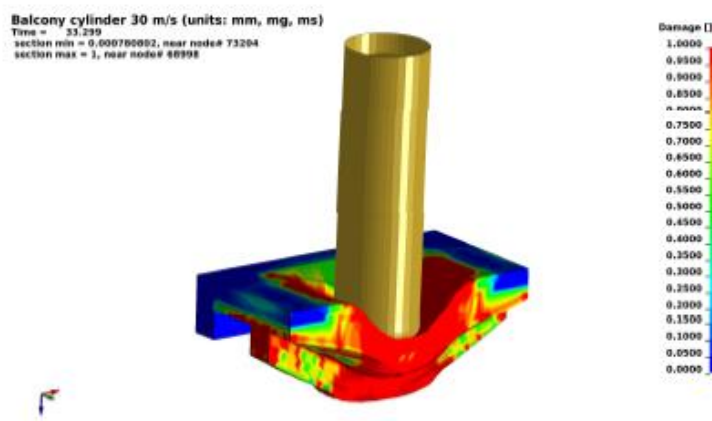

FIGURE A.6.7(b) DAMAGE ON THE CEILING IN THE CASE OF LOW SPEED IMPACT



Red colour indicates zone of complete disintegration

FIGURE A.6.7(c) NUMERICAL MODEL OF THE CRATER

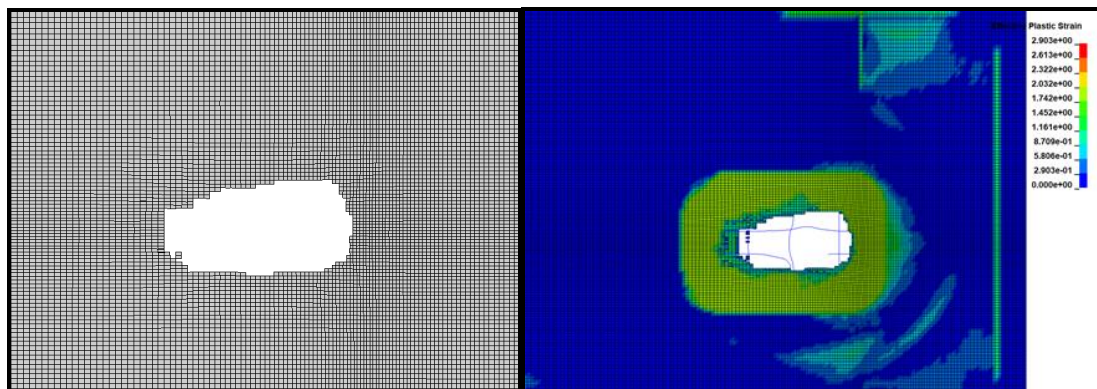

FIGURE A.6.8 CRATER AS SEEN BY FFM INSPECTORS



8. The FFM analysed the damage on the rooftop terrace and below the crater in order to determine if it had been created by an explosive device. However, this hypothesis is unlikely given the absence of primary and secondary fragmentation characteristic of an explosion that may have created the crater and the damage surrounding it.
9. The FFM team noted the blackening of the ceiling and the rim of the aperture from the room immediately below the point of impact (see photo above). It also noted the blackened sooty walls in the corner of the room, as well as what appeared to be the ashen remnants of a small fire. One interviewed witness stated that a fire had been lit in the room after the alleged incident, reportedly to detoxify it of the alleged chemical.

Observed Changes to the Scene

10. The team observed during the visit that certain items were not present that had been seen in open source videos shortly after the alleged event or that had been seen in the video recording and photos taken during the reconnaissance visit. The following points are noted:
 - the cylinder was sampled at least one (1) time prior to the FFM sampling;
 - the cylinder was moved a number of times prior to the FFM visit;
 - debris was moved in front of the cylinder; and
 - the metal frame and fins, visible on the terrace in videos, were missing at the time of the FFM visit.
11. On 26 April the TS requested the SAR to transport the two cylinders that had been observed by the FFM team at Locations 2 and 4 to a safe storage area where the FFM team could apply OPCW tags and seals. SAR representatives informed the team that this would not be possible as the SAR wished to retain the cylinders for criminal investigation purposes. The team leader requested that the SAR inform the TS of this decision through a formal written reply to Note Verbale NV/ODG/214836/18. This was sent to the Technical Secretariat on 4 May. On 4 June, FFM team members tagged and sealed the cylinders from Locations 2 and 4, and documented the procedure.

Annex 7

VISIT TO LOCATION 4

Visit to Location 4 (“cylinder in the bedroom”)

FIGURE A.7.1 THE AREA IN WHICH THE CYLINDER WAS OBSERVED IN A BEDROOM IN A TOP FLOOR APARTMENT

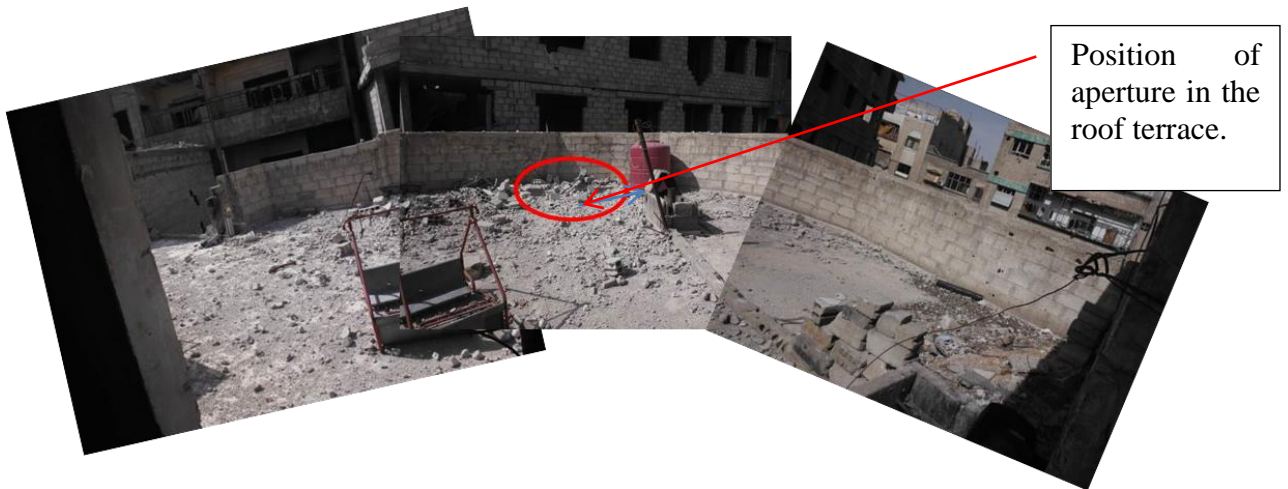

FIGURE A.7.2 LOCATION IN WHICH THE CYLINDER WAS OBSERVED IN A BEDROOM IN A TOP FLOOR APARTMENT



Area shaded in red marks the roof of Location 4

FIGURE A.7.3 ROOF OF LOCATION 4



Position of aperture in the roof terrace.

The aperture was located close to a surrounding wall and next to the water tank with approximate dimensions of 166 x 105 cm. The distance from the adjacent building varies between 230 cm and 250 cm.

FIGURE A.7.4 CRATER ON THE ROOF OF LOCATION 4



FIGURE A.7.5 STRUCTURE OF THE CYLINDER WITH HARNESS AND STABILISING FINS

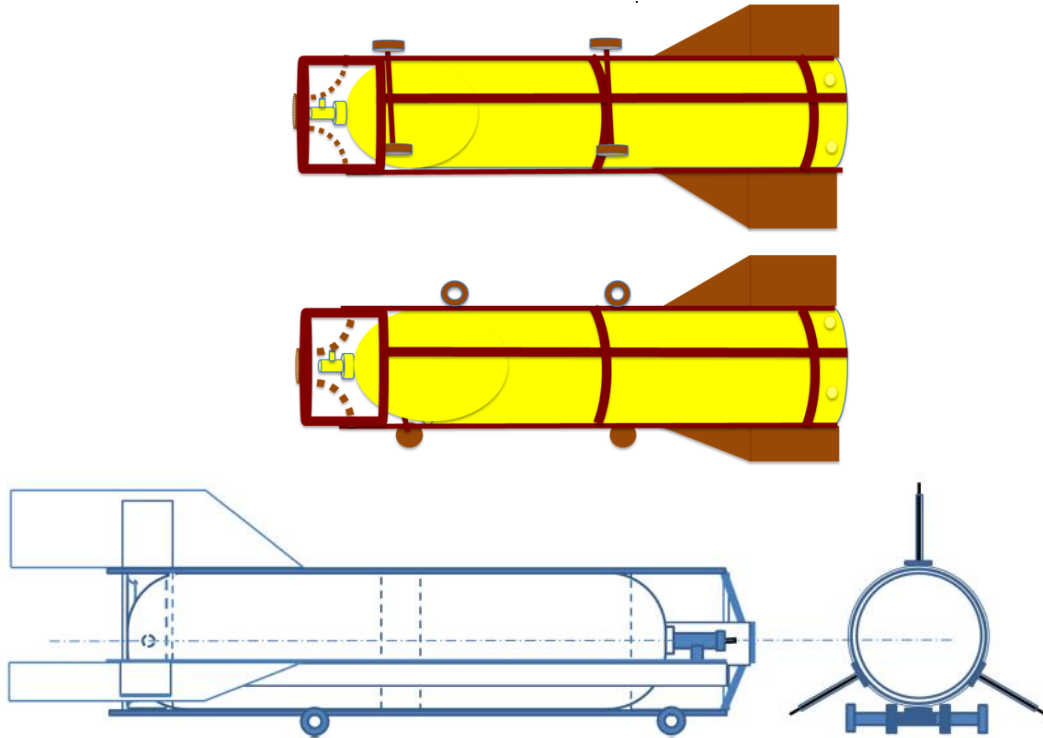
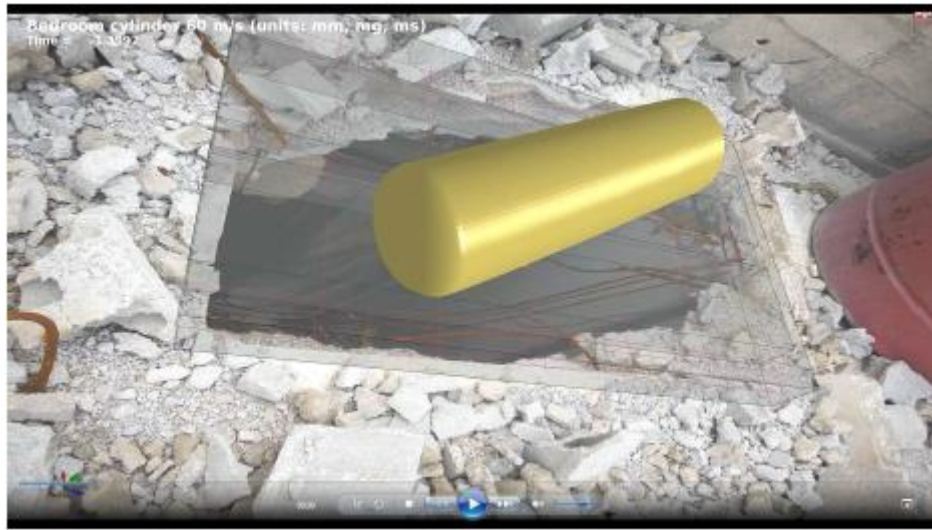

FIGURE A.7.6 SCALE REPRESENTATION OF LAYOUT OF LOCATION 4 ("CYLINDER IN A BEDROOM")

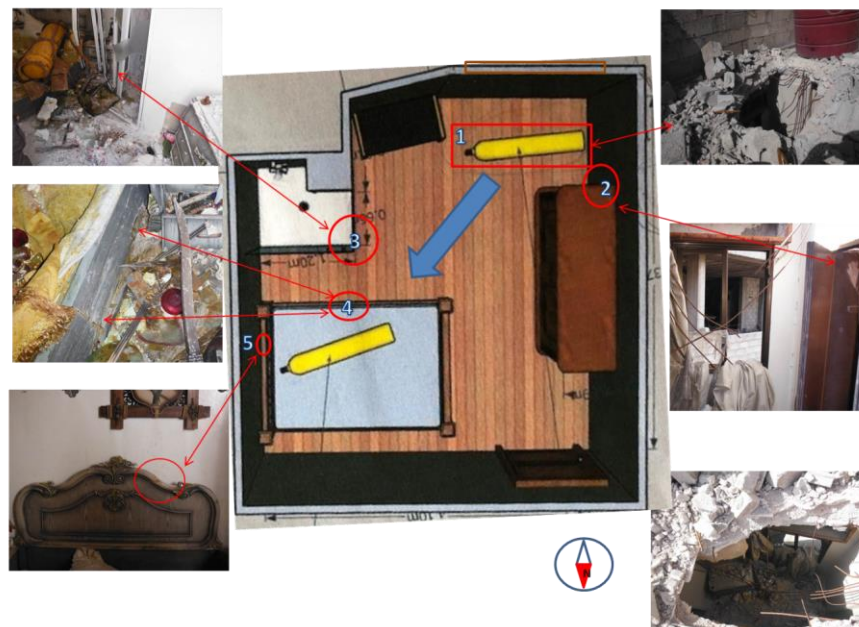

FIGURE A.7.6 SNAPSHOT OF SIMULATION OF THE POSSIBLE ROOF CRATER FORMATION



Considering the proximity of the water tank, the neighbouring buildings, and the surrounding wall adjacent to the hole in the roof, it was concluded that the cylinder impacted the roof as shown in Figure A.7.6. From the shape of the crater and damage on the cylinder, it is likely that the cylinder landed parallel to the ground creating a crater with dimensions of approximately 166 x 105 cm, which is in keeping with the dimensions of cylinder of 140 x 35 cm. It should be noted that the cylinder had an additional structure attached to the body, which is still in line with the dimensions of the crater. The damage observed on site by the FFM team and the possible trajectory of the cylinder based on observed damage and numerical calculations are represented in Figure A.7.7.

FIGURE A.7.7: POSSIBLE TRAJECTORY OF THE CYLINDER INSIDE THE ROOM



Observed changes to the scene

The team observed some differences in the state and content, as well as location of certain items in the room, when referenced to open source videos released shortly after the alleged event. The observed changes are listed below:

- The cylinder appears to have been cleaned. The layer of a white powder seen in the videos was not present when the FFM team visited the location.

FIGURE A.7.8 CHANGES IN THE SCENE



- The bedside lamp on the right side (towards the window) had been moved and was also missing in some photos.
- The FFM team observed a viscous liquid throughout the room, which was not apparent in videos. The same liquid was observed also before the entrance to the apartment and on disposable gloves present at the location (Annex 5).
- The round object similar to the funnel cap found at Location 2 was seen on the open source video.

FIGURE A.7.9 FUNNEL CAP



- Another discrepancy observed while comparing open source videos issued before the FFM visit is related to the cup on the shower cabin. In the initial videos, the cup was not present but on the photos and videos taken by the FFM, the cup is visible.

FIGURE A.7.10 OTHER DISCREPANCIES



Annex 8

VISIT TO THE WAREHOUSE AND FACILITY SUSPECTED OF PRODUCING CHEMICAL WEAPONS

Introduction

1. In a note verbale to the Secretariat on 20 April 2018, a request was made by the SAR for the FFM team, which was currently deployed in Damascus to investigate the alleged use of chemical weapons in Douma on 7 April 2018, to visit, as part of a broader investigation into the above incident, a warehouse where numerous chemical substances were found. After SAR forces commandeered the area, a specialised team was tasked by the Syrian authorities to visit the warehouse on 19 April 2018. The team reported that the warehouse was a six room basement containing a large number of various chemical substances that were relevant both to the production of chemical weapons and explosives. Posterior to receiving the Note Verbale, a public source video-recording of the warehouse was provided by HQ to the FFM team along with a request for the team to conduct a technical evaluation and provide a recommendation on the relevance of the request to the FFM mission.

Visit to Warehouse

2. The FFM team deployed to the warehouse on 27 April 2018 to collect samples and take photos and physical measurements. The coordinates for the warehouse were measured as N 33° 34' 24", E 36° 23' 41.1". There were difficulties initially for the FFM team in gaining safe access to the basement where the warehouse was located. The team's monitoring equipment showed low oxygen levels in the basement as well as high levels of nitrous oxides. Both readings precluded a safe entry of the team and corrective measures had to be instigated. With the assistance of the representatives of the SAR it was possible to ventilate the basement sufficiently to bring oxygen and nitrous oxide levels to within acceptable levels to allow the team to safely work.
3. The warehouse was located in the basement and ground floor of a structurally damaged apartment block. The storage area comprised multiple rooms segregated by concrete walls where chemicals of various types and quantities were stored. Numerous anti-tank mines and mortars were scattered on the floor throughout the basement. On the floor directly above the storage area there was an item of equipment which appeared to be an oxygen generator along with bags of "Dr Oxygen", a substance used to produce oxygen. All the chemicals present, many of which had labels or markings written in Arabic, were photographed, translated where necessary, and subsequently classified.

FIGURE A.8.1 LAYOUT OF THE WAREHOUSE IS GIVEN BELOW (NOT TO SCALE)

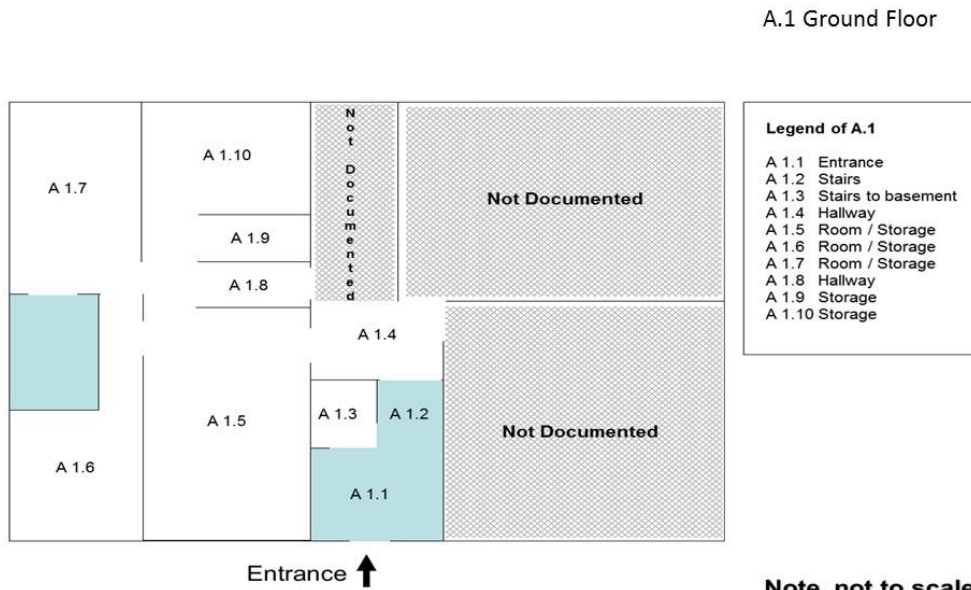
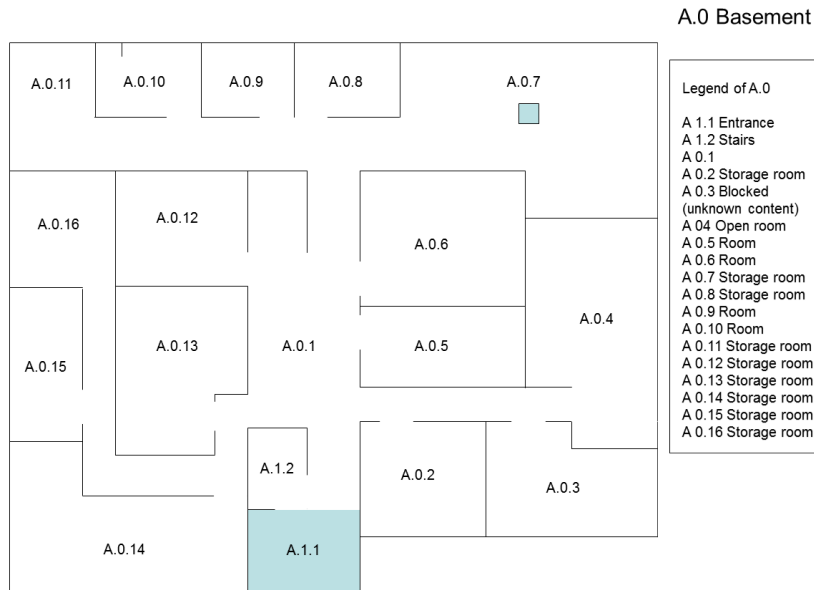

Note, not to scale

TABLE A.8.1 LIST OF SUBSTANCES OBSERVED ON LABELS IN THE WAREHOUSE.

Labelling	Labelling
Cobalt octoate	Packing substances
Dr. Oxygen (for oxygen generation)	Stearic acid
Methyl ethyl ketone (MEK)	Enamel paint
Butyl acetate	Nickel sulfate
Butyl glycoether	Sodium carbonate
Dibutyl phthalate (DBP)	Sulfur
Toluene	Agricultural sulfur
Desmophen A 760 BA/X (hydroxyl bearing polyacrylate)	Oil 2.5
Carboxyl methyl cellulose (CMC)	Resin
TAJ Brilliant Freshness (Detergent)	Sulfuric acid
Engineering Plastics	Sodium nitrate
Aqua 95	Potassium nitrate
MHM	Ammonium perchlorate
Uplex	Polyamide granules
Methyl acetate	Wax
Desmodur NS (Resin solution)	Iron oxide
Lead octoate	Sodium hydroxide
Acetone	Butoxyethanol
Desmodur L 75 (Aromatic polyisocyanate based on toluene diisocyanate)	Burnt oil
EcoC (wetted with)	Hexanoic acid
Lama (Waterproofing polymer)	Anti-freeze
Calcium carbonate	Chlorinated paraffin
ROSK K 26 FASS 226 (contains styrene)	Propyl acetate
Diethanolamine	Sodium bicarbonate
LG – PP Seetec (polypropylene)	Potassium carbonate
Plastichem (plastics from Sprea Group)	Diesel
Hexamine	Polyethylene
Hydrochloric acid	Glycol
Propylene glycol	Vaseline
Diethylene glycol	Cytidine
Acrylic resin	Nitrocellulose
Xanthan	Aluminium sulfate
FLASH (Detergent for bathrooms)	

4. The chemicals identified and which were present in bulk quantities are precursors that are consistent with the production of explosives and propellants. Chemicals such as hexamine, diethylene glycol, carboxymethyl cellulose, toluene, acetone, sulphur, potassium nitrate, dibutyl phthalate, and diethanolamine are all key precursors for the production of explosives and propellants such as RDX, trinitrotoluene (TNT), nitrocellulose, nitrodiethanolamine dinitrate, ethylene glycol dinitrate and gun powder. Although nitric acid, the key nitrating agent for explosives production, was not observed by the FFM team, several litre quantities were seen in the open source

video of the same warehouse. Large quantities of sulphuric acid, an important chemical in nitration processes, were also present.

5. The FFM team did not observe any major key precursors for the synthesis of chemical weapons agents, particularly for nerve agents such as sarin, or vesicants such as sulphur or nitrogen mustard. Although large quantities of hexamine, which can be used as an acid scavenger in binary-type sarin systems and not as a reactive ingredient, were present, no other sarin precursors were observed. In this context, the presence of hexamine, appeared consistent with the production of explosives such as RDX, for which it is the key ingredient.
6. Sulphur powder that serves as one component of binary VX was also observed. None of the precursors for the other component of the binary system, namely QL, were noted. In this context, the storage of sulphur at the site appeared consistent with the manufacture of gun powder, particularly since potassium nitrate was also present.
7. Although the team confirmed the presence of a yellow cylinder in the warehouse, reported in Note Verbale of the Syrian Arab Republic (Annex 10, point 2) as a chlorine cylinder, due to safety reasons (risk involved in manipulating the valve of the cylinder, see Figure A.8.2) it was not feasible to verify or sample the contents. There were differences in this cylinder compared to those witnessed at Locations 2 and 4. It should be noted that the cylinder was present in its original state and had not been altered. Chlorine gas is generally not a common chlorinating agent in the production of chemical weapons agents, except when used in conjunction with phosphorous trichloride, which was not present. Subsequently, the presence of a cylinder reported as containing chlorine gas is not indicative of the production of explosives.

FIGURE A.8.2 CYLINDER OBSERVED BY THE FFM TEAM AT THE WAREHOUSE



Visit to the facility suspected of producing chemical weapons

8. The facility was visited by the FFM team on 30 April. A description of the building and the main features as observed by the FFM team are provided below.
9. The facility is located in the basement of a multi-storey building located at GPS coordinates N 33° 34' 44.7", E 36° 24' 2.9". There are two main sections to the facility, one apparently for storage of materials and the other a larger open production area. The storage area in the basement which is demarcated by concrete walls into partly separated bays is accessed directly from road level and has dimensions of approximately 15 x 8 metres.
10. Adjacent to the storage area, is a larger open area of approximately 30 x 15 metres where a small amount of chemical production equipment is housed.

FIGURE A.8.3 LAYOUT PRODUCTION AREA AND STORAGE AREA²²

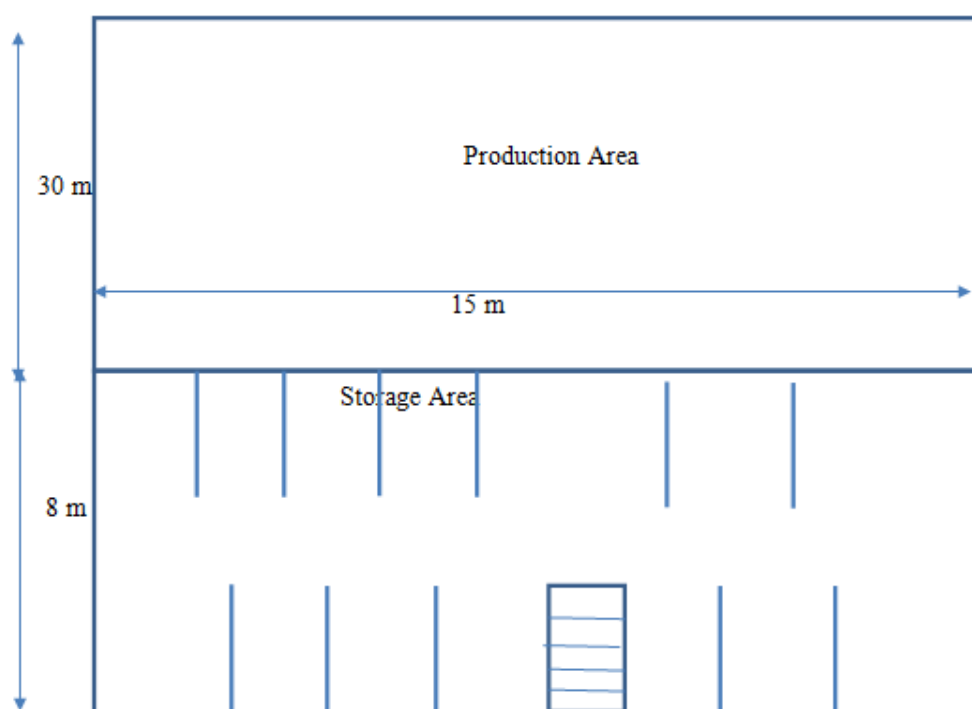

The following was observed in the storage area:

- semi-open bays with concrete-partitioning walls between storage areas;
- bags of powder, mostly unlabelled and some carrying commercial brands such as “Lama” and “Bela”, in addition to wheat flour;
- unmarked metallic and plastic drums. An oily leakage on top of one unmarked plastic drum indicated the presence of nitrogen containing compounds on the team’s detection equipment;

²²

Drawing not proportionally scaled on intention.

- components relevant to explosive devices, such as hand-manufactured detonation cord and a bag labelled “RDX”;
- two cardboard boxes containing laboratory glassware, mostly Erlenmeyer flasks and another containing what appeared to be white ceramic balls;
- a number of 20-litre metallic drums, some fitted with crude cord-type fuses, which appeared to have been filled with plastic explosives to serve as improvised explosive devices; and
- a number of glass jars containing a light-brown waxy solid substance.

It is to be noted that the storage area was not equipped with any mechanical ventilation system.

The following was observed in the production area:

- an open area of approximately 30 x 15 metres;
 - a tiled area that appear to be part of a bathroom and toilet;
 - an improvised extraction hood connected to a vent that was routed through the ceiling. Below were indications of a small open fireplace as well as a cooking pot filled with solid dark flaky substance;
 - an electrical junction box; and
 - chemical production equipment. Details of the production equipment are given below.
11. There were no indications that chemical warfare agents or highly toxic chemicals were being manufactured at this facility. As supporting evidence, the team took two wipe samples from the outlet of the vessel. No chemicals related to the production of chemical weapons were detected.
 12. The mixing vessel was of a specific design, and the team considered that these design features did not make the unit particularly suited for chemical synthesis of toxic or any other chemicals. The installation appeared to be a heating and kneading unit that could be used for filling ammunition with liquid explosives or for mixing explosives with additives. Examples would include mixing of TNT with aluminium to produce tritonal, and mixing of RDX with liquid rubber for the production of plastic explosives.

FIGURE A.8.5 SCHEME OF MIXING VESSEL

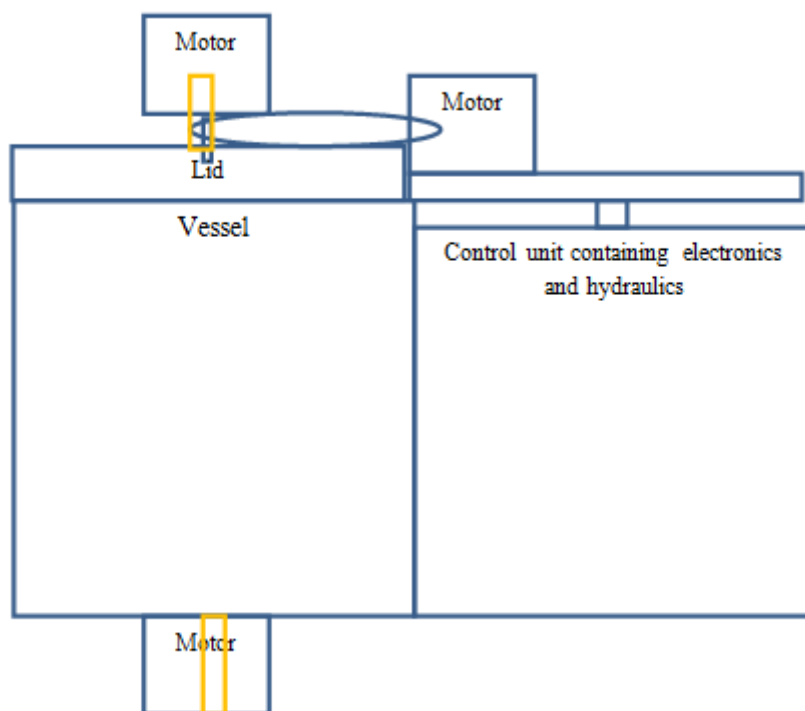

13. Based on the gathered information, the FFM team was not able to establish the link between the warehouse visited on 27 April and the facility suspected of producing chemical weapons.

Description of the production equipment present in the Facility suspected of producing chemical weapons:

- The production equipment appeared to be a purpose-designed stainless steel unit mounted on a sturdy stainless steel frame.
- The main item of equipment included a jacketed stainless steel vessel of roughly 0.75 meters in diameter and 1.2 meters in height, with a volume of 500 litres.
- The vessel was fitted with three motors connected to multiple mixing paddles and a removable lid with a sight glass that could be raised by a hydraulic piston.
- Through the sight glass, residues of a brown paste on the mixing paddles and the walls of the vessel were visible.
- The vessel was fitted with a pressure gauge calibrated to 15 bar.
- There was a service line connected to the top of the jacket, passing through the ceiling from the ground floor above. However, the other end of the service line was not connected to anything at that location. There was another line of similar size exiting the bottom of the vessel jacket, which included a simple pressure relief valve. This appeared to be consistent with a steam jacket serving the vessel for heating, with condensate removal at the bottom.
- There was a line going into the top of the reactor, presumably for addition of water given that the supply line was also connected to washbasins in the room.
- The vessel was served by a control unit in the same support frame. This unit showed a control panel, a hydraulic motor and pump, and electrical connectors.

There were controls for lifting the lid (“up” and “down”), temperature and vacuum.

- There was an outlet valve at the bottom of the vessel.
- The entire assembly was installed within a tiled basin. At one corner of the basin was a loose plastic hose of about 20 cm diameter, apparently used for extraction of vapours or fumes. This was manifolded into plastic piping that was routed up through the ceiling to the next floor (the ground floor), to an induced draught extractor fan. This in turn was connected to plastic piping that went further up the building.
- Next to the production unit was an assembly that appeared to be an improvised cooling water circuit. This included an air conditioning unit manifolded to a heat exchanger with interconnected circulating lines. It was not connected to the main production unit.
- Other items seen in the area included gloves, dust masks and a bag of zinc oxide powder.

14. Based on the chemicals and the equipment present, as well as the lack of protective mechanisms against toxic chemicals, it is highly unlikely that chemical weapons agents were being manufactured in the location described. With the chemical ingredients present, or suggested to be present, it is not possible to manufacture either nerve agents or vesicants. Some of the chemicals observed could be used to manufacture at least two of the Schedule 3A chemicals, hydrogen cyanide and cyanogen chloride, both highly toxic blood agents (not found on the location). As these are either low boiling liquids (hydrogen cyanide boils at 26 °C) or gases (cyanogen chloride boils at 13 °C), it would make it very difficult to handle these chemicals, particularly in the absence of any personal protective equipment, abatement systems or appropriate storage equipment.
15. On the other hand, there is high consistency between the equipment and chemicals present in terms of production of explosives. All of the chemicals observed are common in the production of explosives and propellants.

Annex 9

INFORMATION COLLECTED BY THE FFM

Tables A9.1, A9.2, and A9.3 below summarise the list of physical data collected from various sources by the FFM. It is split into electronic evidence stored in electronic media storage devices such as USB sticks and micro SD cards, hard copy evidence, and samples. Electronic files include audio-visual captions, still images, and documents. Hard copy files consist of various documents, including drawings made by witnesses. The tables also show the list of samples collected from various sources which include environmental and biomedical samples.

Table A9.1 ELECTRONIC DATA COLLECTED BY THE FACT-FINDING MISSION

Electronic data collected by the FFM																																																																																																																																																					
Entry number	Assigned Package Code		Folder location																																																																																																																																																		
1.	1508		D:\1508\Camera 1 - 1508\removable disk\dcim\104_fuji\																																																																																																																																																		
File names																																																																																																																																																					
dscf4405.jpg	dscf4424.jpg	dscf4443.jpg	dscf4462.jpg	dscf4481.jpg	dscf4500.jpg	dscf4519.jpg	dscf4538.jpg	dscf4557.jpg	dscf4576.jpg	dscf4406.jpg	dscf4425.jpg	dscf4444.jpg	dscf4463.jpg	dscf4482.jpg	dscf4501.jpg	dscf4520.jpg	dscf4539.jpg	dscf4558.jpg	dscf4577.jpg	dscf4407.jpg	dscf4426.jpg	dscf4445.jpg	dscf4464.jpg	dscf4483.jpg	dscf4502.jpg	dscf4521.jpg	dscf4540.jpg	dscf4559.jpg	dscf4578.jpg	dscf4408.jpg	dscf4427.jpg	dscf4446.jpg	dscf4465.jpg	dscf4484.jpg	dscf4503.jpg	dscf4522.jpg	dscf4541.jpg	dscf4560.jpg	dscf4579.jpg	dscf4409.jpg	dscf4428.jpg	dscf4447.jpg	dscf4466.jpg	dscf4485.jpg	dscf4504.jpg	dscf4523.jpg	dscf4542.jpg	dscf4561.jpg	dscf4580.jpg	dscf4410.jpg	dscf4429.jpg	dscf4448.jpg	dscf4467.jpg	dscf4486.jpg	dscf4505.jpg	dscf4524.jpg	dscf4543.jpg	dscf4562.jpg	dscf4581.jpg	dscf4411.jpg	dscf4430.jpg	dscf4449.jpg	dscf4468.jpg	dscf4487.jpg	dscf4506.jpg	dscf4525.jpg	dscf4544.jpg	dscf4563.jpg	dscf4582.jpg	dscf4412.jpg	dscf4431.jpg	dscf4450.jpg	dscf4469.jpg	dscf4488.jpg	dscf4507.jpg	dscf4526.jpg	dscf4545.jpg	dscf4564.jpg	dscf4583.jpg	dscf4413.jpg	dscf4432.jpg	dscf4451.jpg	dscf4470.jpg	dscf4489.jpg	dscf4508.jpg	dscf4527.jpg	dscf4546.jpg	dscf4565.jpg	dscf4584.jpg	dscf4414.jpg	dscf4433.jpg	dscf4452.jpg	dscf4471.jpg	dscf4490.jpg	dscf4509.jpg	dscf4528.jpg	dscf4547.jpg	dscf4566.jpg	dscf4585.jpg	dscf4415.jpg	dscf4434.jpg	dscf4453.jpg	dscf4472.jpg	dscf4491.jpg	dscf4510.jpg	dscf4529.jpg	dscf4548.jpg	dscf4567.jpg	dscf4586.jpg	dscf4416.jpg	dscf4435.jpg	dscf4454.jpg	dscf4473.jpg	dscf4492.jpg	dscf4511.jpg	dscf4530.jpg	dscf4549.jpg	dscf4568.jpg	dscf4587.jpg	dscf4417.jpg	dscf4436.jpg	dscf4455.jpg	dscf4474.jpg	dscf4493.jpg	dscf4512.jpg	dscf4531.jpg	dscf4550.jpg	dscf4569.jpg	dscf4588.jpg	dscf4418.jpg	dscf4437.jpg	dscf4456.jpg	dscf4475.jpg	dscf4494.jpg	dscf4513.jpg	dscf4532.jpg	dscf4551.jpg	dscf4570.jpg	dscf4589.jpg	dscf4419.jpg	dscf4438.jpg	dscf4457.jpg	dscf4476.jpg	dscf4495.jpg	dscf4514.jpg	dscf4533.jpg	dscf4552.jpg	dscf4571.jpg	dscf4590.jpg

Electronic data collected by the FFM												
Entry number	Assigned Package Code				Folder location							
1.	1508				D:\1508\Camera 2 - 1508\removable disk\dcim\100nikon\							
dscf4420.jpg	dscf4439.jpg	dscf4458.jpg	dscf4477.jpg	dscf4496.jpg	dscf4515.jpg	dscf4534.jpg	dscf4553.jpg	dscf4572.jpg	dscf4591.jpg			
dscf4421.jpg	dscf4440.jpg	dscf4459.jpg	dscf4478.jpg	dscf4497.jpg	dscf4516.jpg	dscf4535.jpg	dscf4554.jpg	dscf4573.jpg	dscf4592.jpg			
dscf4422.jpg	dscf4441.jpg	dscf4460.jpg	dscf4479.jpg	dscf4498.jpg	dscf4517.jpg	dscf4536.jpg	dscf4555.jpg	dscf4574.jpg	dscf4593.jpg			
dscf4423.jpg	dscf4442.jpg	dscf4461.jpg	dscf4480.jpg	dscf4499.jpg	dscf4518.jpg	dscf4537.jpg	dscf4556.jpg	dscf4575.jpg	dscf4594.jpg			
Entry number	Assigned Package Code				Folder location							
1.	1508				D:\1508\Camera 2 - 1508\removable disk\dcim\100nikon\							
dscn2306.mov	dscn2313.jpg	dscn2320.jpg	dscn2327.jpg	dscn2334.jpg	dscn2341.jpg	dscn2348.jpg	dscn2355.jpg	dscn2362.jpg	dscn2369.jpg			
dscn2307.jpg	dscn2314.jpg	dscn2321.jpg	dscn2328.jpg	dscn2335.jpg	dscn2342.jpg	dscn2349.jpg	dscn2356.jpg	dscn2363.jpg	dscn2370.jpg			
dscn2308.jpg	dscn2315.jpg	dscn2322.jpg	dscn2329.jpg	dscn2336.jpg	dscn2343.jpg	dscn2350.jpg	dscn2357.jpg	dscn2364.jpg	dscn2371.jpg			
dscn2309.jpg	dscn2316.jpg	dscn2323.jpg	dscn2330.jpg	dscn2337.jpg	dscn2344.jpg	dscn2351.jpg	dscn2358.jpg	dscn2365.jpg	dscn2372.jpg			
dscn2310.jpg	dscn2317.jpg	dscn2324.jpg	dscn2331.jpg	dscn2338.jpg	dscn2345.jpg	dscn2352.jpg	dscn2359.jpg	dscn2366.jpg	dscn2373.jpg			
dscn2311.jpg	dscn2318.jpg	dscn2325.jpg	dscn2332.jpg	dscn2339.jpg	dscn2346.jpg	dscn2353.jpg	dscn2360.jpg	dscn2367.jpg	dscn2374.jpg			
dscn2312.jpg	dscn2319.jpg	dscn2326.jpg	dscn2333.jpg	dscn2340.jpg	dscn2347.jpg	dscn2354.jpg	dscn2361.jpg	dscn2368.jpg	dscn2375.jpg			
dscn2306.mov	dscn2313.jpg	dscn2320.jpg	dscn2327.jpg	dscn2334.jpg	dscn2341.jpg	dscn2348.jpg	dscn2355.jpg	dscn2362.jpg	dscn2369.jpg			
Entry number	Assigned Package Code				Folder location							
1.	1508				D:\1508\Video Camera - 1508\removable disk\avf_info\							
avin0001.bnp	avin0001.bnp				avin0001.int							
avin0001.bnp	avin0001.inp				avin0001.int							
avin0001.bnp	avin0001.inp				avin0001.inp							
Entry number	Assigned Package Code				Folder location							
1.	1508				D:\1508\Video Camera - 1508\removable disk\dcim\100msdcf\							
dsc00682.jpg	dsc00683.jpg	dsc00684.jpg	dsc00685.jpg	dsc00686.jpg	dsc00687.jpg	dsc00688.jpg	dsc00689.jpg	dsc00690.jpg				
Entry number	Assigned Package Code				Folder location							
1.	1508				D:\1508\Video Camera - 1508\removable disk\mp_root\100anv01\							
mah00681.mp4	mah00692.mp4	mah00694.mp4	mah00696.mp4	mah00698.mp4	mah00700.mp4	mah00702.mp4	mah00681.mp4					
mah00681.thm	mah00692.thm	mah00694.thm	mah00696.thm	mah00698.thm	mah00700.thm	mah00702.thm	mah00681.thm					
mah00691.mp4	mah00693.mp4	mah00695.mp4	mah00697.mp4	mah00699.mp4	mah00701.mp4	mah00703.mp4	mah00691.mp4					
Entry number	Assigned Package Code				Folder location							
2.	1741				D:\1741\evidence\1741 original\محزرة الكيمياء\اخراج الكيمياء\							
٢٠١٨٠٤٢٥_١٥٠٣٢٢.png	٢٠١٨٠٤٢٥_١٥١٠١٤.png				٢٠١٨٠٤٢٥_١٥١٣٠٢.png				٢٠١٨٠٤٢٥_١٥١٤٠٢.png			

Electronic data collected by the FFM									
050a4783.jpg	050a4792.jpg	٢٠١٨٠٤٠٧_١٦٠٩٢٦.jpg	٢٠١٨٠٤٠٧_١٦٢٨٤٨.mp4	٢٠١٨٠٤٠٨_٠٢٠٢١٩.mp4					
٢٠١٨٠٤٠٨_٠٢٠٣٢٩.mp4	٢٠١٨٠٤٠٨_٠٢٠٤٠٩.jpg	٢٠١٨٠٤٠٨_٠٢٠٤٢٧.mp4	٢٠١٨٠٤٠٨_٠٢٠٥٢٥.jpg	٢٠١٨٠٤١١_٠٠٣٤٣١.mp4					
٢٠١٨٠٤١١_٠٠٣٥٢٥.mp4	٢٠١٨٠٤١١_٠٠٣٥٣٢.jpg	٢٠١٨٠٤١١_٠٠٣٦٣٨.jpg	٢٠١٨٠٤١١_٠٠٣٦٤٤.jpg	٢٠١٨٠٤١١_٠٠٤١٠٠.mp4					
Entry number	Assigned Package Code	Folder location							
4.	1748	D:\1748\evidence\							
fb_img_1439762277929.jpg	vid-20180416-wa0057.mp4	010 صوت sd.m4a	٢٠١٨٠٤١١_١٤٠١٩.jpg						
Entry number	Assigned Package Code	Folder location	File Name						
5.	1757	D:\1757\evidence\	00010.mts						
Entry number	Assigned Package Code	Folder location							
5.	1757	D:\1757\evidence\تحقيق							
imag0090.jpg	video0005.mp4	video0006.mp4	video0007.mp4	video0008.mp4	video0009.mp4	video0010.mp4	video0016.mp4		
video0017.mp4	video0018.mp4	video0019.mp4	video0028.mp4	video0029.mp4	video0030.mp4	video0053.mp4	video0054.mp4		
Entry number	Assigned Package Code	Folder location							
6.	1779	D:\1779\Camera 1 - 1779\removable disk\dcm\103_fuji\							
dscf3538.jpg	dscf3547.jpg	dscf3556.jpg	dscf3565.jpg	dscf3574.jpg	dscf3583.jpg	dscf3592.jpg	dscf3601.jpg	dscf3610.jpg	
dscf3539.jpg	dscf3548.jpg	dscf3557.jpg	dscf3566.jpg	dscf3575.jpg	dscf3584.jpg	dscf3593.jpg	dscf3602.jpg	dscf3611.jpg	
dscf3540.jpg	dscf3549.jpg	dscf3558.jpg	dscf3567.jpg	dscf3576.jpg	dscf3585.jpg	dscf3594.jpg	dscf3603.jpg	dscf3612.jpg	
dscf3541.jpg	dscf3550.jpg	dscf3559.jpg	dscf3568.jpg	dscf3577.jpg	dscf3586.jpg	dscf3595.jpg	dscf3604.jpg	dscf3613.jpg	
dscf3542.jpg	dscf3551.jpg	dscf3560.jpg	dscf3569.jpg	dscf3578.jpg	dscf3587.jpg	dscf3596.jpg	dscf3605.jpg	dscf3614.jpg	
dscf3543.jpg	dscf3552.jpg	dscf3561.jpg	dscf3570.jpg	dscf3579.jpg	dscf3588.jpg	dscf3597.jpg	dscf3606.jpg	dscf3615.jpg	
dscf3544.jpg	dscf3553.jpg	dscf3562.jpg	dscf3571.jpg	dscf3580.jpg	dscf3589.jpg	dscf3598.jpg	dscf3607.jpg	dscf3616.jpg	
dscf3545.jpg	dscf3554.jpg	dscf3563.jpg	dscf3572.jpg	dscf3581.jpg	dscf3590.jpg	dscf3599.jpg	dscf3608.jpg	dscf3617.jpg	
Entry number	Assigned Package Code	Folder location							
6.	1779	D:\1779\Camera 2 - 1779\removable disk\dcm\104_fuji\							
dscf4595.jpg	dscf4600.jpg	dscf4605.jpg	dscf4610.jpg	dscf4615.jpg	dscf4620.jpg	dscf4625.jpg	dscf4630.jpg	dscf4635.jpg	dscf4640.jpg
dscf4596.jpg	dscf4601.jpg	dscf4606.jpg	dscf4611.jpg	dscf4616.jpg	dscf4621.jpg	dscf4626.jpg	dscf4631.jpg	dscf4636.jpg	dscf4641.jpg
dscf4597.jpg	dscf4602.jpg	dscf4607.jpg	dscf4612.jpg	dscf4617.jpg	dscf4622.jpg	dscf4627.jpg	dscf4632.jpg	dscf4637.jpg	dscf4642.jpg
dscf4598.jpg	dscf4603.jpg	dscf4608.jpg	dscf4613.jpg	dscf4618.jpg	dscf4623.jpg	dscf4628.jpg	dscf4633.jpg	dscf4638.jpg	dscf4643.jpg

Electronic data collected by the FFM											
Entry number	Assigned Package Code	Folder location									
dscf4599.jpg	dscf4604.jpg	dscf4609.jpg	dscf4614.jpg	dscf4619.jpg	dscf4624.jpg	dscf4629.jpg	dscf4634.jpg	dscf4639.jpg	dscf4644.jpg	dscf4649.jpg	
dscf4645.jpg	dscf4646.jpg	dscf4647.jpg	D:\1779\Camera 3 - 1779\removable disk\dcim\100nikon\								
6.	1779	D:\1779\Camera 3 - 1779\removable disk\dcim\100nikon\									
dscn2376.jpg	dscn2377.jpg	dscn2378.jpg	dscn2379.jpg	dscn2380.jpg	dscn2381.jpg	dscn2382.jpg	dscn2383.jpg	dscn2384.jpg	dscn2385.jpg	dscn2385.jpg	
dscn2386.jpg	dscn2387.jpg	dscn2388.jpg	dscn2389.jpg	dscn2390.jpg	dscn2391.jpg	dscn2392.jpg	dscn2393.jpg	dscn2394.jpg	dscn2395.jpg	dscn2395.jpg	
dscn2396.jpg	dscn2397.jpg	dscn2398.jpg	dscn2399.jpg	dscn2400.jpg	dscn2401.jpg	dscn2402.jpg	dscn2403.jpg	dscn2404.jpg	dscn2405.jpg	dscn2405.jpg	
dscn2406.jpg	dscn2407.jpg	dscn2408.jpg	dscn2409.jpg	dscn2410.jpg	dscn2411.jpg	dscn2412.jpg	dscn2413.jpg	dscn2414.jpg	dscn2415.jpg	dscn2415.jpg	
dscn2416.jpg	dscn2417.jpg	dscn2418.jpg	dscn2419.jpg	dscn2420.jpg	dscn2421.jpg	dscn2422.jpg	dscn2423.jpg	dscn2424.jpg	dscn2425.jpg	dscn2425.jpg	
dscn2426.jpg	dscn2427.jpg	dscn2428.mov	dscn2429.jpg	dscn2430.jpg	dscn2431.jpg	dscn2432.jpg	dscn2433.jpg	Folder location			
6.	1779	D:\1779\Video of repacking samples - 1779\removable disk\mp_root\100anv01\									
avin0001.bnp	avin0001.inp	avin0001.int	prv00001.bin								
Entry number	Assigned Package Code	Folder location									
6.	1779	D:\1779\Video of repacking samples - 1779\removable disk\avf_info\									
mah00704.mp4	mah00704.thm	mah00705.mp4	mah00705.thm								
Entry number	Assigned Package Code	Folder location									
6.	1779	D:\1779\Video of repacking samples - 1779\removable disk\private\avchd\bdmv\clipinf\									
00000.cpi	00001.cpi	00002.cpi	00002.cpi								
Entry number	Assigned Package Code	Folder location									
6.	1779	D:\1779\Video of repacking samples - 1779\removable disk\private\avchd\bdmv\									
index.bdm	movieobj.bdm	movieobj.bdm									
Entry number	Assigned Package Code	Folder location									
8.	1788	D:\1779\Video of repacking samples - 1779\removable disk\private\avchd\bdmv\playlist\									
00000.mpl	00000.mpl	00000.mpl									
Entry number	Assigned Package Code	Folder location									
6.	1779	D:\1779\Video of repacking samples - 1779\removable disk\private\avchd\bdmv\stream\									
00000.mts	00001.mts	00002.mts	00002.mts								
Entry number	Assigned Package Code	Folder location									
6.	1779	D:\1779\Video of repacking samples - 1779\removable disk\private\avchd\bdmv\									

Electronic data collected by the FFM															
7.		D:\1782\1782\sd\dcim\105_fuji\													
1782															
dscf5499.jpg	dscf5515.jpg	dscf5531.jpg	dscf5547.jpg	dscf5563.jpg	dscf5579.jpg	dscf5595.jpg	dscf5611.jpg	dscf5627.jpg	dscf5643.jpg						
dscf5500.jpg	dscf5516.jpg	dscf5532.jpg	dscf5548.jpg	dscf5564.jpg	dscf5580.jpg	dscf5596.jpg	dscf5612.jpg	dscf5628.jpg	dscf5644.jpg						
dscf5501.jpg	dscf5517.jpg	dscf5533.jpg	dscf5549.jpg	dscf5565.jpg	dscf5581.jpg	dscf5597.jpg	dscf5613.jpg	dscf5629.jpg	dscf5645.jpg						
dscf5502.jpg	dscf5518.jpg	dscf5534.jpg	dscf5550.jpg	dscf5566.jpg	dscf5582.jpg	dscf5598.jpg	dscf5614.jpg	dscf5630.jpg	dscf5646.jpg						
dscf5503.jpg	dscf5519.jpg	dscf5535.jpg	dscf5551.jpg	dscf5567.jpg	dscf5583.jpg	dscf5599.jpg	dscf5615.jpg	dscf5631.jpg	dscf5647.jpg						
dscf5504.jpg	dscf5520.jpg	dscf5536.jpg	dscf5552.jpg	dscf5568.jpg	dscf5584.jpg	dscf5600.jpg	dscf5616.jpg	dscf5632.jpg	dscf5648.jpg						
dscf5505.jpg	dscf5521.jpg	dscf5537.jpg	dscf5553.jpg	dscf5569.jpg	dscf5585.jpg	dscf5601.jpg	dscf5617.jpg	dscf5633.jpg	dscf5649.jpg						
dscf5506.jpg	dscf5522.jpg	dscf5538.jpg	dscf5554.jpg	dscf5570.jpg	dscf5586.jpg	dscf5602.jpg	dscf5618.jpg	dscf5634.jpg	dscf5650.jpg						
dscf5507.jpg	dscf5523.jpg	dscf5539.jpg	dscf5555.jpg	dscf5571.jpg	dscf5587.jpg	dscf5603.jpg	dscf5619.jpg	dscf5635.jpg	dscf5651.jpg						
dscf5508.jpg	dscf5524.jpg	dscf5540.jpg	dscf5556.jpg	dscf5572.jpg	dscf5588.jpg	dscf5604.jpg	dscf5620.jpg	dscf5636.jpg	dscf5652.jpg						
dscf5509.jpg	dscf5525.jpg	dscf5541.jpg	dscf5557.jpg	dscf5573.jpg	dscf5589.jpg	dscf5605.jpg	dscf5621.jpg	dscf5637.jpg	dscf5653.jpg						
dscf5510.jpg	dscf5526.jpg	dscf5542.jpg	dscf5558.jpg	dscf5574.jpg	dscf5590.jpg	dscf5606.jpg	dscf5622.jpg	dscf5638.jpg	dscf5654.jpg						
dscf5511.jpg	dscf5527.jpg	dscf5543.jpg	dscf5559.jpg	dscf5575.jpg	dscf5591.jpg	dscf5607.jpg	dscf5623.jpg	dscf5639.jpg	dscf5655.jpg						
dscf5512.jpg	dscf5528.jpg	dscf5544.jpg	dscf5560.jpg	dscf5576.jpg	dscf5592.jpg	dscf5608.jpg	dscf5624.jpg	dscf5640.jpg	dscf5656.jpg						
dscf5513.jpg	dscf5529.jpg	dscf5545.jpg	dscf5561.jpg	dscf5577.jpg	dscf5593.jpg	dscf5609.jpg	dscf5625.jpg	dscf5641.jpg	dscf5657.jpg						
dscf5514.jpg	dscf5530.jpg	dscf5546.jpg	dscf5562.jpg	dscf5578.jpg	dscf5594.jpg	dscf5610.jpg	dscf5626.jpg	dscf5642.jpg	dscf5658.jpg						
dscf5659.jpg															
Entry number		Assigned Package Code			Folder location										
8.		1788			D:\1788\100GOPRO A.G\										
gopr0001.jpg		gopr0002.jpg			gopr0003.jpg			gopr0004.lrv		gopr0004.mp4		gopr0004.thm			
Entry number		Assigned Package Code			Folder location										
8.		1788			D:\1788\100GOPRO M.F\										
gopr0001.lrv		gopr0001.mp4			gopr0001.thm			gp010001.lrv		gp010001.mp4		gp020001.lrv		gp020001.mp4	
gp030001.lrv		gp030001.mp4			gp040001.lrv			gp040001.lrv		gp050001.lrv		gp050001.mp4		gp060001.lrv	
gp060001.mp4		gp070001.lrv			gp070001.mp4			gp080001.lrv		gp080001.mp4		gp090001.lrv		gp090001.mp4	
Entry number		Assigned Package Code			Folder location										

Electronic data collected by the FFM											
8.	1788	D:\1788\101GOPRO M.L\									
gopr0001.lrv	gopr0001.lrv	gopr0001.lrv	gopr0001.lrv	gopr0001.lrv	gopr0001.lrv	gopr0001.lrv	gopr0001.lrv	gopr0001.lrv	gopr0001.lrv		
Entry number		Assigned Package Code								Folder location	
8.	1788	D:\1788\101NIKON M.L\100gopro m.l\									
gopr0001.lrv	gopr0001.mp4	gopr0001.thm	gopr0002.lrv	gopr0002.lrv	gopr0002.mp4	gopr0002.thm					
Entry number		Assigned Package Code								Folder location	
8.	1788	D:\1788\101NIKON M.L\									
dscn2096.jpg	dscn2103.jpg	dscn2110.jpg	dscn2117.jpg	dscn2124.mov	dscn2131.jpg	dscn2138.jpg	dscn2145.jpg	dscn2152.jpg			
dscn2097.jpg	dscn2104.jpg	dscn2111.jpg	dscn2118.jpg	dscn2125.mov	dscn2132.jpg	dscn2139.jpg	dscn2146.jpg	dscn2153.jpg			
dscn2098.jpg	dscn2105.jpg	dscn2112.jpg	dscn2119.jpg	dscn2126.mov	dscn2133.jpg	dscn2140.jpg	dscn2147.jpg	dscn2154.jpg			
dscn2099.jpg	dscn2106.jpg	dscn2113.jpg	dscn2120.jpg	dscn2127.jpg	dscn2134.jpg	dscn2141.jpg	dscn2148.jpg	dscn2155.jpg			
dscn2100.jpg	dscn2107.jpg	dscn2114.jpg	dscn2121.jpg	dscn2128.mov	dscn2135.jpg	dscn2142.jpg	dscn2149.jpg	dscn2156.jpg			
dscn2101.jpg	dscn2108.jpg	dscn2115.jpg	dscn2122.jpg	dscn2129.jpg	dscn2136.jpg	dscn2143.jpg	dscn2150.jpg	dscn2157.jpg			
dscn2102.jpg	dscn2109.jpg	dscn2116.jpg	dscn2123.jpg	dscn2130.jpg	dscn2137.jpg	dscn2144.jpg	dscn2151.jpg	dscn2158.jpg			
		dscn2159.jpg	dscn2160.jpg								dscn2161.jpg
Entry number		Assigned Package Code								Folder location	
8.	1788	D:\1788\103_FUJI A.G\									
dscf3444.jpg	dscf3452.jpg	dscf3460.jpg	dscf3468.jpg	dscf3476.jpg	dscf3484.jpg	dscf3492.jpg	dscf3500.jpg	dscf3508.jpg	dscf3516.jpg		
dscf3445.jpg	dscf3453.jpg	dscf3461.jpg	dscf3469.jpg	dscf3477.jpg	dscf3485.jpg	dscf3493.jpg	dscf3501.jpg	dscf3509.jpg	dscf3517.jpg		
dscf3446.jpg	dscf3454.jpg	dscf3462.jpg	dscf3470.jpg	dscf3478.jpg	dscf3486.jpg	dscf3494.jpg	dscf3502.jpg	dscf3510.jpg	dscf3518.jpg		
dscf3447.jpg	dscf3455.jpg	dscf3463.jpg	dscf3471.jpg	dscf3479.jpg	dscf3487.jpg	dscf3495.jpg	dscf3503.jpg	dscf3511.jpg	dscf3519.jpg		
dscf3448.jpg	dscf3456.jpg	dscf3464.jpg	dscf3472.jpg	dscf3480.jpg	dscf3488.jpg	dscf3496.jpg	dscf3504.jpg	dscf3512.jpg	dscf3520.jpg		
dscf3449.jpg	dscf3457.jpg	dscf3465.jpg	dscf3473.jpg	dscf3481.jpg	dscf3489.jpg	dscf3497.jpg	dscf3505.jpg	dscf3513.jpg	dscf3521.jpg		
dscf3450.jpg	dscf3458.jpg	dscf3466.jpg	dscf3474.jpg	dscf3482.jpg	dscf3490.jpg	dscf3498.jpg	dscf3506.jpg	dscf3514.jpg	dscf3522.jpg		
dscf3451.jpg	dscf3459.jpg	dscf3467.jpg	dscf3475.jpg	dscf3483.jpg	dscf3491.jpg	dscf3499.jpg	dscf3507.jpg	dscf3515.jpg	dscf3523.jpg		
dscf3524.jpg			dscf3525.jpg	dscf3526.jpg	dscf3527.jpg	dscf3528.jpg	dscf3529.jpg				
Entry number		Assigned Package Code								Folder location	

Electronic data collected by the FFM										
Entry number	Assigned Package Code	Folder location								
9.	1799	D:\1799\evidence\آخرى تصويرات								
		photo_2018-04-07_16-55-05.jpg	photo_2018-04-07_23-31-13.jpg	photo_2018-04-07_23-31-17.jpg	photo_2018-04-07_23-31-17.jpg					
		photo_2018-04-07_16-55-07.jpg	photo_2018-04-07_23-31-14.jpg	photo_2018-04-07_23-31-20.jpg	photo_2018-04-07_23-31-20.jpg					
		photo_2018-04-07_23-31-10.jpg	photo_2018-04-07_23-31-15.jpg	photo_2018-04-08_01-01-38.jpg	photo_2018-04-08_01-01-38.jpg					
		photo_2018-04-07_23-31-12.jpg	photo_2018-04-07_23-31-16.jpg	photo_2018-04-08_02-24-57.jpg	photo_2018-04-08_02-24-57.jpg					
		photo_2018-04-08_02-25-03.jpg								
Entry number	Assigned Package Code	Folder location				File Name				
9.	1799	D:\1799\evidence\تصويري				20180409_190227.mp4				
Entry number	Assigned Package Code	Folder location								
9.	1799	D:\1799\evidence\								
		dsc_0060.jpg	mov_0059.mp4							mov_0062.mp4
Entry number	Assigned Package Code	Folder location								
10.	1900	D:\1900\evidence\								
dsc_0153.mov	dsc_0233.mov	dsc_0234.mov	dsc_0235.mov	imag0957.jpg	imag0958.jpg	imag0959.jpg	imag0959.jpg	imag0960.jpg	imag0960.jpg	
		video0219.mp4								
Entry number	Assigned Package Code	Folder location								
11.	1909	D:\1909\100GOPRO A.G\								
gopr0001.lrv	gopr0001.mp4	gopr0001.thm	gopr0002.lrv	gopr0002.lrv	gopr0002.mp4	gopr0002.thm	gopr0002.thm	gp010001.lrv	gp010001.lrv	
gp010001.mp4	gp020001.lrv	gp020001.mp4	gp030001.lrv	gp030001.lrv	gp030001.mp4	gp040001.lrv	gp040001.lrv	gp040001.mp4	gp040001.mp4	
Entry number	Assigned Package Code	Folder location								
11.	1909	D:\1909\100GOPRO I.H\								
gopr0001.lrv	gopr0001.mp4	gopr0001.thm	gopr0002.lrv	gopr0002.lrv	gopr0002.mp4	gopr0002.thm	gopr0002.thm	gp010001.lrv	gp010001.mp4	
gp020001.lrv	gp020001.mp4	gp030001.lrv	gp030001.lrv	gp030001.mp4	gp040001.lrv	gp040001.mp4	gp050001.lrv	gp050001.lrv	gp050001.mp4	
Entry number	Assigned Package Code	Folder location								
11.	1909	D:\1909\100GOPRO M.F\								
gopr0001.lrv	gopr0001.mp4	gopr0001.thm	gopr0001.lrv	gopr0001.lrv	gp010001.mp4	gp010001.lrv	gp020001.lrv	gp020001.lrv	gp020001.mp4	
gp030001.lrv	gp030001.mp4	gp040001.lrv	gp040001.lrv	gp040001.mp4	gp050001.lrv	gp050001.lrv	gp050001.mp4	gp050001.lrv	gp060001.lrv	

Electronic data collected by the FFM									
dscf3442.jpg		dscf3443.jpg		dscf3444.jpg					
Entry number	Assigned Package Code			Folder location					
11.	1909			D:\1909\103_FUJI M.F					
dscf3661.jpg	dscf3672.jpg	dscf3683.jpg	dscf3694.jpg	dscf3705.jpg	dscf3716.jpg	dscf3727.jpg	dscf3738.jpg	dscf3749.jpg	dscf3760.jpg
dscf3662.jpg	dscf3673.jpg	dscf3684.jpg	dscf3695.jpg	dscf3706.jpg	dscf3717.jpg	dscf3728.jpg	dscf3739.jpg	dscf3750.jpg	dscf3761.jpg
dscf3663.jpg	dscf3674.jpg	dscf3685.jpg	dscf3696.jpg	dscf3707.jpg	dscf3718.jpg	dscf3729.jpg	dscf3740.jpg	dscf3751.jpg	dscf3762.jpg
dscf3664.jpg	dscf3675.jpg	dscf3686.jpg	dscf3697.jpg	dscf3708.jpg	dscf3719.jpg	dscf3730.jpg	dscf3741.jpg	dscf3752.jpg	dscf3763.jpg
dscf3665.jpg	dscf3676.jpg	dscf3687.jpg	dscf3698.jpg	dscf3709.jpg	dscf3720.jpg	dscf3731.jpg	dscf3742.jpg	dscf3753.jpg	dscf3764.jpg
dscf3666.jpg	dscf3677.jpg	dscf3688.jpg	dscf3699.jpg	dscf3710.jpg	dscf3721.jpg	dscf3732.jpg	dscf3743.jpg	dscf3754.jpg	dscf3765.jpg
dscf3667.jpg	dscf3678.jpg	dscf3689.jpg	dscf3700.jpg	dscf3711.jpg	dscf3722.jpg	dscf3733.jpg	dscf3744.jpg	dscf3755.jpg	dscf3766.jpg
dscf3668.jpg	dscf3679.jpg	dscf3690.jpg	dscf3701.jpg	dscf3712.jpg	dscf3723.jpg	dscf3734.jpg	dscf3745.jpg	dscf3756.jpg	dscf3767.jpg
dscf3669.jpg	dscf3680.jpg	dscf3691.jpg	dscf3702.jpg	dscf3713.jpg	dscf3724.jpg	dscf3735.jpg	dscf3746.jpg	dscf3757.jpg	dscf3768.jpg
dscf3670.jpg	dscf3681.jpg	dscf3692.jpg	dscf3703.jpg	dscf3714.jpg	dscf3725.jpg	dscf3736.jpg	dscf3747.jpg	dscf3758.jpg	dscf3769.jpg
dscf3771.jpg	dscf3772.jpg			dscf3773.jpg					
Entry number	Assigned Package Code			Folder location					
11.	1909			D:\1909\Rece 17042018\sd\dcim\100gopro\					
gopr0001.lrv	gopr0001.mp4	gopr0001.thm	gopr0002.lrv	gopr0002.thm	gopr0002.mp4	gopr0002.thm	gopr0003.lrv	gopr0003.mp4	gopr0003.thm
gopr0004.lrv	gopr0004.mp4	gopr0004.thm	gopr0005.lrv	gopr0005.thm	gopr0005.mp4	gopr0005.thm	gopr0006.lrv	gopr0006.mp4	gopr0006.thm
Entry number	Assigned Package Code			Folder location					
11.	1909			D:\1909\Rece20042018\sd\dcim\100gopro\					
gopr0001.lrv	gopr0001.mp4	gopr0001.thm	gopr0002.lrv	gopr0002.thm	gopr0002.mp4	gopr0002.thm	gopr0003.lrv	gopr0003.mp4	gopr0003.thm
gopr0003.thm	gopr0004.lrv	gopr0004.mp4	gopr0004.thm	gopr0005.lrv	gopr0005.thm	gopr0005.mp4	gopr0005.thm	gopr0006.lrv	gopr0006.thm
gopr0006.mp4	gopr0006.thm			gp010006.lrv					
Entry number	Assigned Package Code			Folder location					
12.	1914			D:\1914\Camera 1 - 1914\removable disk\dcim\103_fuji\					
dscf3946.jpg	dscf3947.jpg	dscf3948.jpg	dscf3949.jpg	dscf3950.jpg	dscf3951.jpg	dscf3952.jpg	dscf3953.jpg	dscf3954.jpg	dscf3955.jpg
dscf3956.jpg	dscf3957.jpg	dscf3958.jpg	dscf3959.jpg	dscf3960.jpg	dscf3961.jpg	dscf3962.jpg	dscf3963.jpg	dscf3964.jpg	dscf3965.jpg
dscf3966.jpg	dscf3967.jpg	dscf3968.jpg	dscf3969.jpg	dscf3970.jpg	dscf3971.jpg	dscf3972.jpg	dscf3973.jpg	dscf3974.jpg	dscf3975.jpg

Electronic data collected by the FFM										
dscf3976.jpg	dscf3977.jpg	dscf3978.jpg	dscf3979.jpg	dscf3980.jpg	dscf3981.jpg	dscf3982.jpg	dscf3983.jpg	dscf3984.jpg	dscf3985.jpg	
dscf3986.jpg	dscf3987.jpg	dscf3988.jpg	dscf3989.jpg	dscf3990.jpg	dscf3991.jpg	dscf3992.jpg	dscf3993.jpg	dscf3994.jpg	dscf3995.jpg	
dscf3996.jpg			dscf3997.jpg			dscf3998.jpg				
Entry number	Assigned Package Code		Folder location							
12.	1914		D:\1914\Camera 1 - 1914\removable disk\dcim\104_fuji\							
dscf4001.jpg	dscf4041.jpg	dscf4081.jpg	dscf4121.jpg	dscf4161.jpg	dscf4201.jpg	dscf4241.jpg	dscf4281.jpg	dscf4321.jpg	dscf4361.jpg	
dscf4002.jpg	dscf4042.jpg	dscf4082.jpg	dscf4122.jpg	dscf4162.jpg	dscf4202.jpg	dscf4242.jpg	dscf4282.jpg	dscf4322.jpg	dscf4362.jpg	
dscf4003.jpg	dscf4043.jpg	dscf4083.jpg	dscf4123.jpg	dscf4163.jpg	dscf4203.jpg	dscf4243.jpg	dscf4283.jpg	dscf4323.jpg	dscf4363.jpg	
dscf4004.jpg	dscf4044.jpg	dscf4084.jpg	dscf4124.jpg	dscf4164.jpg	dscf4204.jpg	dscf4244.jpg	dscf4284.jpg	dscf4324.jpg	dscf4364.jpg	
dscf4005.jpg	dscf4045.jpg	dscf4085.jpg	dscf4125.jpg	dscf4165.jpg	dscf4205.jpg	dscf4245.jpg	dscf4285.jpg	dscf4325.jpg	dscf4365.jpg	
dscf4006.jpg	dscf4046.jpg	dscf4086.jpg	dscf4126.jpg	dscf4166.jpg	dscf4206.jpg	dscf4246.jpg	dscf4286.jpg	dscf4326.jpg	dscf4366.jpg	
dscf4007.jpg	dscf4047.jpg	dscf4087.jpg	dscf4127.jpg	dscf4167.jpg	dscf4207.jpg	dscf4247.jpg	dscf4287.jpg	dscf4327.jpg	dscf4367.jpg	
dscf4008.jpg	dscf4048.jpg	dscf4088.jpg	dscf4128.jpg	dscf4168.jpg	dscf4208.jpg	dscf4248.jpg	dscf4288.jpg	dscf4328.jpg	dscf4368.jpg	
dscf4009.jpg	dscf4049.jpg	dscf4089.jpg	dscf4129.jpg	dscf4169.jpg	dscf4209.jpg	dscf4249.jpg	dscf4289.jpg	dscf4329.jpg	dscf4369.jpg	
dscf4010.jpg	dscf4050.jpg	dscf4090.jpg	dscf4130.jpg	dscf4170.jpg	dscf4210.jpg	dscf4250.jpg	dscf4290.jpg	dscf4330.jpg	dscf4370.jpg	
dscf4011.jpg	dscf4051.jpg	dscf4091.jpg	dscf4131.jpg	dscf4171.jpg	dscf4211.jpg	dscf4251.jpg	dscf4291.jpg	dscf4331.jpg	dscf4371.jpg	
dscf4012.jpg	dscf4052.jpg	dscf4092.jpg	dscf4132.jpg	dscf4172.jpg	dscf4212.jpg	dscf4252.jpg	dscf4292.jpg	dscf4332.jpg	dscf4372.jpg	
dscf4013.jpg	dscf4053.jpg	dscf4093.jpg	dscf4133.jpg	dscf4173.jpg	dscf4213.jpg	dscf4253.jpg	dscf4293.jpg	dscf4333.jpg	dscf4373.jpg	
dscf4014.jpg	dscf4054.jpg	dscf4094.jpg	dscf4134.jpg	dscf4174.jpg	dscf4214.jpg	dscf4254.jpg	dscf4294.jpg	dscf4334.jpg	dscf4374.jpg	
dscf4015.jpg	dscf4055.jpg	dscf4095.jpg	dscf4135.jpg	dscf4175.jpg	dscf4215.jpg	dscf4255.jpg	dscf4295.jpg	dscf4335.jpg	dscf4375.jpg	
dscf4016.jpg	dscf4056.jpg	dscf4096.jpg	dscf4136.jpg	dscf4176.jpg	dscf4216.jpg	dscf4256.jpg	dscf4296.jpg	dscf4336.jpg	dscf4376.jpg	
dscf4017.jpg	dscf4057.jpg	dscf4097.jpg	dscf4137.jpg	dscf4177.jpg	dscf4217.jpg	dscf4257.jpg	dscf4297.jpg	dscf4337.jpg	dscf4377.jpg	
dscf4018.jpg	dscf4058.jpg	dscf4098.jpg	dscf4138.jpg	dscf4178.jpg	dscf4218.jpg	dscf4258.jpg	dscf4298.jpg	dscf4338.jpg	dscf4378.jpg	
dscf4019.jpg	dscf4059.jpg	dscf4099.jpg	dscf4139.jpg	dscf4179.jpg	dscf4219.jpg	dscf4259.jpg	dscf4299.jpg	dscf4339.jpg	dscf4379.jpg	
dscf4020.jpg	dscf4060.jpg	dscf4100.jpg	dscf4140.jpg	dscf4180.jpg	dscf4220.jpg	dscf4260.jpg	dscf4300.jpg	dscf4340.jpg	dscf4380.jpg	
dscf4021.jpg	dscf4061.jpg	dscf4101.jpg	dscf4141.jpg	dscf4181.jpg	dscf4221.jpg	dscf4261.jpg	dscf4301.jpg	dscf4341.jpg	dscf4381.jpg	
dscf4022.jpg	dscf4062.jpg	dscf4102.jpg	dscf4142.jpg	dscf4182.jpg	dscf4222.jpg	dscf4262.jpg	dscf4302.jpg	dscf4342.jpg	dscf4382.jpg	
dscf4023.jpg	dscf4063.jpg	dscf4103.jpg	dscf4143.jpg	dscf4183.jpg	dscf4223.jpg	dscf4263.jpg	dscf4303.jpg	dscf4343.jpg	dscf4383.jpg	

Electronic data collected by the FFM																
dscf4024.jpg	dscf4064.jpg	dscf4104.jpg	dscf4144.jpg	dscf4184.jpg	dscf4224.jpg	dscf4264.jpg	dscf4304.jpg	dscf4344.jpg	dscf4384.jpg	dscf4145.jpg	dscf4185.jpg	dscf4225.jpg	dscf4265.jpg	dscf4305.jpg	dscf4345.jpg	dscf4385.jpg
dscf4025.jpg	dscf4065.jpg	dscf4105.jpg	dscf4145.jpg	dscf4185.jpg	dscf4225.jpg	dscf4265.jpg	dscf4305.jpg	dscf4345.jpg	dscf4385.jpg	dscf4146.jpg	dscf4186.jpg	dscf4226.jpg	dscf4266.jpg	dscf4306.jpg	dscf4346.jpg	dscf4386.jpg
dscf4026.jpg	dscf4066.jpg	dscf4106.jpg	dscf4146.jpg	dscf4186.jpg	dscf4226.jpg	dscf4266.jpg	dscf4306.jpg	dscf4346.jpg	dscf4386.jpg	dscf4147.jpg	dscf4187.jpg	dscf4227.jpg	dscf4267.jpg	dscf4307.jpg	dscf4347.jpg	dscf4387.jpg
dscf4027.jpg	dscf4067.jpg	dscf4107.jpg	dscf4147.jpg	dscf4187.jpg	dscf4227.jpg	dscf4267.jpg	dscf4307.jpg	dscf4347.jpg	dscf4387.jpg	dscf4148.jpg	dscf4188.jpg	dscf4228.jpg	dscf4268.jpg	dscf4308.jpg	dscf4348.jpg	dscf4388.jpg
dscf4028.jpg	dscf4068.jpg	dscf4108.jpg	dscf4148.jpg	dscf4188.jpg	dscf4228.jpg	dscf4268.jpg	dscf4308.jpg	dscf4348.jpg	dscf4388.jpg	dscf4149.jpg	dscf4189.jpg	dscf4229.jpg	dscf4269.jpg	dscf4309.jpg	dscf4349.jpg	dscf4389.jpg
dscf4029.jpg	dscf4069.jpg	dscf4109.jpg	dscf4149.jpg	dscf4189.jpg	dscf4229.jpg	dscf4269.jpg	dscf4309.jpg	dscf4349.jpg	dscf4389.jpg	dscf4150.jpg	dscf4190.jpg	dscf4230.jpg	dscf4270.jpg	dscf4310.jpg	dscf4350.jpg	dscf4390.jpg
dscf4030.jpg	dscf4070.jpg	dscf4110.jpg	dscf4150.jpg	dscf4190.jpg	dscf4230.jpg	dscf4270.jpg	dscf4310.jpg	dscf4350.jpg	dscf4390.jpg	dscf4151.jpg	dscf4191.jpg	dscf4231.jpg	dscf4271.jpg	dscf4311.jpg	dscf4351.jpg	dscf4391.jpg
dscf4031.jpg	dscf4071.jpg	dscf4111.jpg	dscf4151.jpg	dscf4191.jpg	dscf4231.jpg	dscf4271.jpg	dscf4311.jpg	dscf4351.jpg	dscf4391.jpg	dscf4152.jpg	dscf4192.jpg	dscf4232.jpg	dscf4272.jpg	dscf4312.jpg	dscf4352.jpg	dscf4392.jpg
dscf4032.jpg	dscf4072.jpg	dscf4112.jpg	dscf4152.jpg	dscf4192.jpg	dscf4232.jpg	dscf4272.jpg	dscf4312.jpg	dscf4352.jpg	dscf4392.jpg	dscf4153.jpg	dscf4193.jpg	dscf4233.jpg	dscf4273.jpg	dscf4313.jpg	dscf4353.jpg	dscf4393.jpg
dscf4033.jpg	dscf4073.jpg	dscf4113.jpg	dscf4153.jpg	dscf4193.jpg	dscf4233.jpg	dscf4273.jpg	dscf4313.jpg	dscf4353.jpg	dscf4393.jpg	dscf4154.jpg	dscf4194.jpg	dscf4234.jpg	dscf4274.jpg	dscf4314.jpg	dscf4354.jpg	dscf4394.jpg
dscf4034.jpg	dscf4074.jpg	dscf4114.jpg	dscf4154.jpg	dscf4194.jpg	dscf4234.jpg	dscf4274.jpg	dscf4314.jpg	dscf4354.jpg	dscf4394.jpg	dscf4155.jpg	dscf4195.jpg	dscf4235.jpg	dscf4275.jpg	dscf4315.jpg	dscf4355.jpg	dscf4395.jpg
dscf4035.jpg	dscf4075.jpg	dscf4115.jpg	dscf4155.jpg	dscf4195.jpg	dscf4235.jpg	dscf4275.jpg	dscf4315.jpg	dscf4355.jpg	dscf4395.jpg	dscf4156.jpg	dscf4196.jpg	dscf4236.jpg	dscf4276.jpg	dscf4316.jpg	dscf4356.jpg	dscf4396.jpg
dscf4036.jpg	dscf4076.jpg	dscf4116.jpg	dscf4156.jpg	dscf4196.jpg	dscf4236.jpg	dscf4276.jpg	dscf4316.jpg	dscf4356.jpg	dscf4396.jpg	dscf4157.jpg	dscf4197.jpg	dscf4237.jpg	dscf4277.jpg	dscf4317.jpg	dscf4357.jpg	dscf4397.jpg
dscf4037.jpg	dscf4077.jpg	dscf4117.jpg	dscf4157.jpg	dscf4197.jpg	dscf4237.jpg	dscf4277.jpg	dscf4317.jpg	dscf4357.jpg	dscf4397.jpg	dscf4158.jpg	dscf4198.jpg	dscf4238.jpg	dscf4278.jpg	dscf4318.jpg	dscf4358.jpg	dscf4398.jpg
dscf4038.jpg	dscf4078.jpg	dscf4118.jpg	dscf4158.jpg	dscf4198.jpg	dscf4238.jpg	dscf4278.jpg	dscf4318.jpg	dscf4358.jpg	dscf4398.jpg	dscf4159.jpg	dscf4199.jpg	dscf4239.jpg	dscf4279.jpg	dscf4319.jpg	dscf4359.jpg	dscf4399.jpg
dscf4039.jpg	dscf4079.jpg	dscf4119.jpg	dscf4159.jpg	dscf4199.jpg	dscf4239.jpg	dscf4279.jpg	dscf4319.jpg	dscf4359.jpg	dscf4399.jpg	dscf4160.jpg	dscf4200.jpg	dscf4240.jpg	dscf4280.jpg	dscf4320.jpg	dscf4360.jpg	dscf4400.jpg
dscf4040.jpg	dscf4080.jpg	dscf4120.jpg	dscf4160.jpg	dscf4200.jpg	dscf4240.jpg	dscf4280.jpg	dscf4320.jpg	dscf4360.jpg	dscf4400.jpg	dscf4401.jpg	dscf4402.jpg	dscf4403.jpg	dscf4404.jpg			
Entry number	Assigned Package Code	Folder location														
12.	1914	D:\1914\Camera 2 - 1914\removable disk(dcim\100nikon\)														
dscn2162.jpg	dscn2177.jpg	dscn2192.jpg	dscn2207.jpg	dscn2222.jpg	dscn2236.jpg	dscn2250.jpg	dscn2264.jpg	dscn2278.jpg	dscn2292.jpg	dscn2178.jpg	dscn2208.jpg	dscn2223.jpg	dscn2237.jpg	dscn2251.jpg	dscn2265.jpg	dscn2279.jpg
dscn2163.jpg	dscn2178.jpg	dscn2193.jpg	dscn2208.jpg	dscn2223.jpg	dscn2237.jpg	dscn2251.jpg	dscn2265.jpg	dscn2279.jpg	dscn2293.jpg	dscn2179.jpg	dscn2209.jpg	dscn2224.jpg	dscn2238.jpg	dscn2252.jpg	dscn2266.jpg	dscn2280.jpg
dscn2164.jpg	dscn2179.jpg	dscn2194.jpg	dscn2209.jpg	dscn2224.jpg	dscn2238.jpg	dscn2252.jpg	dscn2266.jpg	dscn2280.jpg	dscn2294.jpg	dscn2180.jpg	dscn2210.jpg	dscn2225.jpg	dscn2239.jpg	dscn2253.jpg	dscn2267.jpg	dscn2281.jpg
dscn2165.jpg	dscn2180.jpg	dscn2195.jpg	dscn2210.jpg	dscn2225.jpg	dscn2239.jpg	dscn2253.jpg	dscn2267.jpg	dscn2281.jpg	dscn2295.jpg	dscn2181.jpg	dscn2211.jpg	dscn2226.jpg	dscn2240.jpg	dscn2254.jpg	dscn2268.jpg	dscn2282.jpg
dscn2166.jpg	dscn2181.jpg	dscn2196.jpg	dscn2211.jpg	dscn2226.jpg	dscn2240.jpg	dscn2254.jpg	dscn2268.jpg	dscn2282.jpg	dscn2296.jpg	dscn2182.jpg	dscn2212.jpg	dscn2227.jpg	dscn2241.jpg	dscn2255.jpg	dscn2269.jpg	dscn2283.jpg
dscn2167.jpg	dscn2182.jpg	dscn2197.jpg	dscn2212.jpg	dscn2227.jpg	dscn2241.jpg	dscn2255.jpg	dscn2269.jpg	dscn2283.jpg	dscn2297.jpg	dscn2183.jpg	dscn2213.jpg	dscn2228.jpg	dscn2242.jpg	dscn2256.jpg	dscn2270.jpg	dscn2284.jpg
dscn2168.jpg	dscn2183.jpg	dscn2198.jpg	dscn2213.jpg	dscn2228.jpg	dscn2242.jpg	dscn2256.jpg	dscn2270.jpg	dscn2284.jpg	dscn2298.jpg	dscn2184.jpg	dscn2214.jpg	dscn2229.jpg	dscn2243.jpg	dscn2257.jpg	dscn2271.jpg	dscn2285.jpg
dscn2169.jpg	dscn2184.jpg	dscn2199.jpg	dscn2214.jpg	dscn2229.jpg	dscn2243.jpg	dscn2257.jpg	dscn2271.jpg	dscn2285.jpg	dscn2299.jpg							

Electronic data collected by the FFM					
Entry number	Assigned Package Code	Folder location			
14.	1515	D:\1515\evidence\توثيق			
1.mov	2.mov	3.mov	4.mov	5.mov	6.mov
mvi_9495.mov	خاص جداً مع عدم النشر	نة مكان مجزرة ال ك يملو	ش شرطة عسكريه ر و س ية لمعالي	ش دخول 4pm	ي ب دوما 4pm توثيق\evidence\1515\evidence\4pm
img_20180411_131559.jpg	img_20180411_132310.jpg	img_20180411_132429.jpg	img_20180411_134107.jpg	img_20180411_134047.jpg	vid_20180411_133553.mp4
img_20180411_131605.jpg	img_20180411_132426.jpg	img_20180411_132433.jpg	img_20180411_134113.jpg	img_20180411_134051.jpg	vid_20180411_133631.mp4
img_20180411_131614.jpg	img_20180411_132446.jpg	img_20180411_132449.jpg	img_20180411_134117.jpg	img_20180411_134107.jpg	vid_20180411_134152.mp4
img_20180411_131620.jpg	img_20180411_132746.jpg	img_20180411_132749.jpg	img_20180411_134950.jpg	img_20180411_134956.jpg	vid_20180411_135015.mp4
img_20180411_131707.jpg	img_20180411_132751.jpg	img_20180411_132753.jpg	img_20180411_134956.jpg	img_20180411_134941.jpg	vid_20180411_135051.mp4
img_20180411_131713.jpg	img_20180411_132756.jpg	img_20180411_133131.jpg	img_20180411_135000.jpg	img_20180411_134941.jpg	٢٠١٨٠٤٠٨_١٧٢٩٥٥.mp4
img_20180411_131716.jpg	img_20180411_132759.jpg	img_20180411_133137.jpg	img_20180411_135005.jpg	img_20180411_134941.jpg	٢٠١٨٠٤٠٨_١٧٣٠٤٧.jpg
img_20180411_131719.jpg	img_20180411_133131.jpg	img_20180411_133137.jpg	img_20180411_135008.jpg	img_20180411_134950.jpg	٢٠١٨٠٤٠٨_١٧٣٠٥٣.jpg
img_20180411_131942.jpg	img_20180411_133137.jpg	img_20180411_133146.jpg	vid_20180411_131315.mp4	img_20180411_134950.jpg	٢٠١٨٠٤٠٨_١٧٣٠٥٥.jpg
img_20180411_131944.jpg	img_20180411_133357.jpg	img_20180411_133146.jpg	vid_20180411_131348.mp4	img_20180411_134956.jpg	٢٠١٨٠٤٠٨_١٧٣٠٥٨.jpg
img_20180411_131946.jpg	img_20180411_133505.jpg	img_20180411_133357.jpg	vid_20180411_131902.mp4	img_20180411_134956.jpg	٢٠١٨٠٤٠٨_١٧٣١٣٣.jpg
img_20180411_131950.jpg	٢٠١٨٠٤٠٨_١٧٥٢٢٠.mp4	img_20180411_133505.jpg	vid_20180411_131933.mp4	img_20180411_135000.jpg	٢٠١٨٠٤٠٨_١٧٣٤٥٠.mp4
img_20180411_131952.jpg	٢٠١٨٠٤٠٨_١٨٥٨٥٩.mp4	img_20180411_133505.jpg	vid_20180411_131933.mp4	img_20180411_135005.jpg	٢٠١٨٠٤٠٨_١٧٣٧٣٤.jpg
img_20180411_131954.jpg	٢٠١٨٠٤٠٨_١٨٥٨٥٩.mp4	img_20180411_133505.jpg	vid_20180411_131933.mp4	img_20180411_135008.jpg	٢٠١٨٠٤٠٨_١٧٣٧٣٩.jpg
img_20180411_132001.jpg	٢٠١٨٠٤٠٨_١٧٥٢٢٠.mp4	img_20180411_133505.jpg	vid_20180411_131933.mp4	vid_20180411_131315.mp4	٢٠١٨٠٤٠٨_١٧٣٧٣٩.jpg
img_20180411_132003.jpg	٢٠١٨٠٤٠٨_١٨٥٨٥٩.mp4	img_20180411_133505.jpg	vid_20180411_131933.mp4	vid_20180411_131348.mp4	٢٠١٨٠٤٠٨_١٧٣٧٤٢.jpg
img_20180411_132007.jpg	٢٠١٨٠٤٠٨_١٧٥٢٢٠.mp4	img_20180411_133505.jpg	vid_20180411_131933.mp4	vid_20180411_131902.mp4	٢٠١٨٠٤٠٨_١٧٣٩٢٠.jpg
٢٠١٨٠٤٠٨_١٧٤٠١٠.mp4	٢٠١٨٠٤٠٨_١٧٥٢٢٠.mp4	img_20180411_133505.jpg	vid_20180411_131933.mp4	vid_20180411_131902.mp4	٢٠١٨٠٤٠٨_١٧٣٩٢٢.jpg
٢٠١٨٠٤٠٨_١٧٥٢٢٠.mp4	٢٠١٨٠٤٠٨_١٨٥٨٥٩.mp4	img_20180411_133505.jpg	vid_20180411_131933.mp4	vid_20180411_131902.mp4	٢٠١٨٠٤٠٨_١٧٤٠١٠.mp4
img_20180411_131125.jpg	٢٠١٨٠٤٠٨_١٧٥٢٢٠.mp4	img_20180411_132009.jpg	vid_20180411_133516.jpg	vid_20180411_133516.jpg	٢٠١٨٠٤٠٨_١٧٥٢٢٠.mp4
		٢٠١٨٠٤٠٨_١٨٥٨٥٩.mp4			vid_20180411_132233.mp4

TABLE A9.2 HARD COPY OF DATA COLLECTED BY THE FACT-FINDING MISSION

Entry number	Assigned Package Code	Evidence Reference Number	Description
1.	1748	20180422174806	Drawing
2.	1748	20180422174807	Drawing
3.	1900	20180427190004	Drawing
4.	1920	20180425192003	Drawing
5.	1793	20180416179303	Drawing
6.	1916	20180416191603	Drawing
7.	1907	20180415190703	Drawing
8.	1931	20181019193103	Drawing
9.	1935	20181018193503	Drawing

Table A9.3 LIST OF SAMPLES COLLECTED OR RECEIVED BY THE FACT-FINDING MISSION

Entry number	Sample Description	Evidence Reference Number	Source
1	Concrete debris from the street, left side below the window (level 0)	20180421190901	Collected by the FFM
2	Concrete debris from the street opposite side of the entry of location 2 (level 0)	20180421190902	Collected by the FFM
3	Concrete debris from the middle of the street opposite to the window (level 0)	20180421190903	Collected by the FFM
4	Control sample: debris 20 meters west of the building entry (level 0)	20180421190904	Collected by the FFM
5	Swab blank with DCM	20180421190905	Collected by the FFM
6	Wipe blank with DCM	20180421190906	Collected by the FFM
7	Swab blank with water	20180421190907	Collected by the FFM
8	Wipe blank with water	20180421190908	Collected by the FFM
9	Fabric stuck to metal bars from the terrace where the cylinder is (level 3)	20180421190909	Collected by the FFM
10	Swab from inside the orifice of the cylinder (level 3)	20180421190910	Collected by the FFM
11	Swab with water from inside the orifice of the cylinder (level 3)	20180421190911	Collected by the FFM
12	Metal fragment from the terrace (level 3)	20180421190912	Collected by the FFM
13	Wipe with DCM from the external surface of the cylinder (level 3)	20180421190913	Collected by the FFM
14	Wipe with water from the external surface of the cylinder (level 3)	20180421190914	Collected by the FFM
15	Dry wipe of the cylinder thread (level 3)	20180421190915	Collected by the FFM
16	Metal object from the terrace (Level 3)	20180421190916	Collected by the FFM
17	Concrete debris from the base of the cylinder (level 3)	20180421190917	Collected by the FFM
18	Metal bar at cylinder nose (Level 3)	20180421190918	Collected by the FFM
19	Concrete debris from the crater-edge in front of the cylinder nose (level 3)	20180421190919	Collected by the FFM
20	Tile from the terrace wall (level 3)	20180421190920	Collected by the FFM
21	Wipe with water from the burnt wall in the room located under the cylinder	20180421190921	Collected by the FFM

Entry number	Sample Description	Evidence Reference Number	Source
	(level 2)		
22	Wipe with DCM from the burnt wall from room under the cylinder (level 2)	20180421190922	Collected by the FFM
23	Swab with water from wall plug in the room under the cylinder (level 2)	20180421190923	Collected by the FFM
24	Dry wipe from the kitchen wall above the oven (level 2)	20180421190924	Collected by the FFM
25	Wood fragment from the kitchen door (level 2)	20180421190925	Collected by the FFM
26	Towel from the room located under the cylinder (level 2)	20180421190926	Collected by the FFM
27	Exposed electrical wires from the room under the cylinder (level 2)	20180421190927	Collected by the FFM
28	Lump of concrete from floor debris in the room under the cylinder (level 2)	20180421190928	Collected by the FFM
29	Soap bar from the room under the cylinder (level 2)	20180421190929	Collected by the FFM
30	Dry wipe from a bicycle rear cassette in the basement (level -1)	20180421190930	Collected by the FFM
31	Swab with DCM from a bicycle rear cassette in the basement (level -1)	20180421190931	Collected by the FFM
32	Water tank wood support in the basement (level -1)	20180421190932	Collected by the FFM
33	Light bulb from the basement (level -1)	20180421190933	Collected by the FFM
34	Wood from the partition frame in the basement (level -1)	20180421190934	Collected by the FFM
35	Water from water tank in basement (level -1)	20180421190935	Collected by the FFM
36	Telephone from the basement (level -1)	20180421190936	Collected by the FFM
37	2 nails and 2 screws from a wall in the basement (level -1)	20180421190937	Collected by the FFM
38	Swab with water from an electric socket in the basement (level -1)	20180421190938	Collected by the FFM
39	Swab with DCM from an electric socket in the basement (level -1)	20180421190939	Collected by the FFM
40	Damp wall board from the basement to the left of the stairs (level -1)	20180421190940	Collected by the FFM
41	Wipe with water from a wall in the basement (level -1)	20180421190941	Collected by the FFM
42	Wipe with DCM from a wall in the basement (level -1)	20180421190942	Collected by the FFM
43	Wipe with water from a lavatory extractor pipe in the basement (level -1)	20180421190943	Collected by the FFM

Entry number	Sample Description	Evidence Reference Number	Source
44	Insect from the lavatory in the basement (level -1)	20180421190944	Collected by the FFM
45	Pillow from the bed under the cylinder	20180425178801	Collected by the FFM
46	Metal fragment from the bedroom floor	20180425178802	Collected by the FFM
47	Metal object from the dresser	20180425178803	Collected by the FFM
48	Piece of blanket under the cylinder	20180425178804	Collected by the FFM
49	Control sample: piece of blanket on the opposite side of the bed, on the floor	20180425178805	Collected by the FFM
50	Wet wood from under the cylinder	20180425178806	Collected by the FFM
51	Insects and dust from the tray in the bedroom shower	20180425178807	Collected by the FFM
52	Bedside lamp on top of the mattress	20180425178808	Collected by the FFM
53	Copper wire attached to the roof, hanging from the ceiling lamp	20180425178809	Collected by the FFM
54	Pillow cover on the bed, closer to the wall	20180425178810	Collected by the FFM
55	Dry wipe from nozzle, front part close to the thread	20180425178811	Collected by the FFM
56	Dry wipe from the cylinder thread	20180425178812	Collected by the FFM
57	Dry wipe from stains on the wall, behind the bed	20180425178813	Collected by the FFM
58	Chips of paint from the wall behind the bed	20180425178814	Collected by the FFM
59	Wipe with DCM blank	20180425178815	Collected by the FFM
60	Wipe with DCM from the headbed	20180425178816	Collected by the FFM
61	Wipe with DCM from the cylinder nozzle	20180425178817	Collected by the FFM
62	Calid paper from wall	20180425178818	Collected by the FFM
63	Gloves from the stairs	20180425178819	Collected by the FFM
64	Wipe with DCM from the door threshold, at the entrance of the apartment	20180425178820	Collected by the FFM
65	Solid sample from a white bag under a jar (made in China) labelled as hexamine	20180427191401	Collected by the FFM
66	Solid sample from a jar labelled as hexamine	20180427191402	Collected by the FFM

Entry number	Sample Description	Evidence Reference Number	Source
67	Solid sample from a white bag next to a jar labelled as hexamine	20180427191403	Collected by the FFM
68	Solid sample from a white bag with Cheminol label and labelled as hexamine	20180427191404	Collected by the FFM
69	Solid sample of unknown blue crystalline solid	20180427191405	Collected by the FFM
70	Solid sample of unknown green solid	20180427191406	Collected by the FFM
71	Swab blank with DCM	20180430150801	Collected by the FFM
72	Swab blank with water	20180430150802	Collected by the FFM
73	Swab sample with DCM from an outlet valve on a reactor	20180430150803	Collected by the FFM
74	Swab sample with water from an outlet valve on a reactor	20180430150804	Collected by the FFM
75	DCM wipe of the wall and floor at hose down area seen in an open source video	20180501177901	Collected by the FFM
76	Water wipe of the wall and floor at hose down area seen in an open source video	20180501177902	Collected by the FFM
77	Swab blank with DCM	20180501177903	Collected by the FFM
78	Wipe blank with water	20180501177904	Collected by the FFM
79	Concrete dust scraping at pillar 51 (control)	20180501177905	Collected by the FFM
80	Concrete dust 5-13 on the right hand side of the wall	20180501177906	Collected by the FFM
81	Grouting from 5-13 c. 1m out from the LHS wall	20180501177907	Collected by the FFM
82	Piece of clothes from a victim	20180421178219	Handed over by 1782
83	Pieces of timber	20180421178220	Handed over by 1782
84	Dark blue vest	20180421178215	Handed over by 1782
85	Scarf collected from the basement	20180422174805	Handed over by 1748
86	Stuffed animal collected from basement	20180422174804	Handed over by 1748
87	Plasma samples	20180421178201	Handed over by 1782
88	Plasma samples	20180421178204	Handed over by 1782

Entry number	Sample Description	Evidence Reference Number	Source
89	Plasma samples	20180421178207	Handed over by 1782
90	Plasma samples	20180421178210	Handed over by 1782
91	Plasma samples	20180421178213	Handed over by 1782
92	Plasma samples	20180418175704A	Handed over by 1757
93	Plasma samples	20180418175703A	Handed over by 1757
94	Plasma samples	20180418175702A	Handed over by 1757
95	Plasma samples	20180418175701A	Handed over by 1757
96	Plasma samples	201804211748PL	Collected by the FFM
97	Plasma samples	201804211795PL	Collected by the FFM
98	Plasma samples	201804211770PL	Collected by the FFM
99	Plasma samples	201804251753PL	Collected by the FFM
100	Blood cell samples	20180421178202	Handed over by 1782
101	Blood cell samples	20180421178205	Handed over by 1782
102	Blood cell samples	20180421178208	Handed over by 1782
103	Blood cell samples	20180421178211	Handed over by 1782
104	Blood cell samples	20180421178214	Handed over by 1782
105	Blood cell samples	20180418175704B	Handed over by 1757
106	Blood cell samples	20180418175703B	Handed over by 1757
107	Blood cell samples	20180418175702B	Handed over by 1757
108	Blood cell samples	20180418175701B	Handed over by 1757
109	Blood cell samples	201804211748BC	Collected by the FFM
110	Blood cell samples	201804211795BC	Collected by the FFM
111	Blood cell samples	201804211770BC	Collected by the FFM

Entry number	Sample Description	Evidence Reference Number	Source
112	Blood cell samples	201804251753BC	Collected by the FFM
113	Full blood samples	20180421178203	Handed over by 1782
114	Full blood samples	20180421178206	Handed over by 1782
115	Full blood samples	20180421178209	Handed over by 1782
116	Full blood samples	20180421178212	Handed over by 1782
117	Hair samples	20180418175705HS	Handed over by 1757
118	Hair samples	20180418175706HS	Handed over by 1757
119	Hair samples	20180418175707HS	Handed over by 1757
120	Hair samples	20180430178226	Handed over by 1782
121	Hair samples	20180430178227	Handed over by 1782
122	Hair samples	20180430178228	Handed over by 1782
123	Hair samples	20180430178229	Handed over by 1782
124	Hair samples	20180430178230	Handed over by 1782
125	DNA samples	20180426178221	Collected by the FFM
126	DNA samples	20180426178222	Collected by the FFM
127	DNA samples	20180426178223	Collected by the FFM
128	DNA samples	20180426178224	Collected by the FFM
129	DNA samples	20180426178225	Collected by the FFM

DOCUMENTS RECEIVED FROM THE STATE PARTY

TABLE A.10.1 NOTES VERBALES RECEIVED FROM THE SYRIAN ARAB REPUBLIC

1. **Note Verbale No. 38:** Permanent Representative of the Syrian Arab Republic requests that a Fact-Finding Mission be dispatched urgently to visit the town of Douma to verify the information surrounding the alleged use of toxic chemicals on 7 April 2018.
2. **Note Verbale No. 43:** from the SAR to the Director General of the OPCW requesting the Director General to instruct the FFM team to carry out a visit to a warehouse containing chemicals and equipment within the framework of the FFM's mission to gather facts surrounding the allegation of use of toxic chemical substances in the city of Douma in Rif Dimashq on 7 April 2018,.
3. **Note Verbale No. 44:** from the SAR to the Director General of the OPCW replying to the Technical Secretariat's note NV/ODG/214836/18, dated April 26th 2018.
4. **Note Verbale No. 45:** from the SAR to the Director General of the OPCW replying to the Technical Secretariat's note NV/ODG/214827/18, dated April 26th 2018.
5. **Note Verbale No. 56:** from the SAR to TS replying to the request to seal the cylinders in Note Verbale NV/ODG/214836/18.
6. **Note Verbale No. 57:** from the SAR replying to the Technical Secretariat's request in Note Verbale (NV/ODG/214827/18) to exhume bodies for the purpose of taking bio samples.
7. **Note Verbale No. 60:** from the SAR: Remarks of the Syrian Arab Republic on the Fact Finding Mission Interim Report on the Alleged Incident in Douma.

Annex 11

DIGITAL INFORMATION ANALYSIS

The FFM team analysed the videos and photos in detail to ascertain their authenticity and potential as confirming evidence.

The analysis involved, inter alia:

1. Gathering metadata to verify the dates and time the videos and photos were created.
2. Corroborating information gathered through interviews. Only digital information that contained metadata was evaluated for the purposes digital information analysis of this report.
3. Comparing clinical signs displayed by the victims in the videos with known presentations of chemical exposure.

MEDIA FILES RECEIVED BY THE FFM

A total of 206 media files were collected directly from witnesses, namely videos and photographs (Annex 9).

Media files received from witnesses

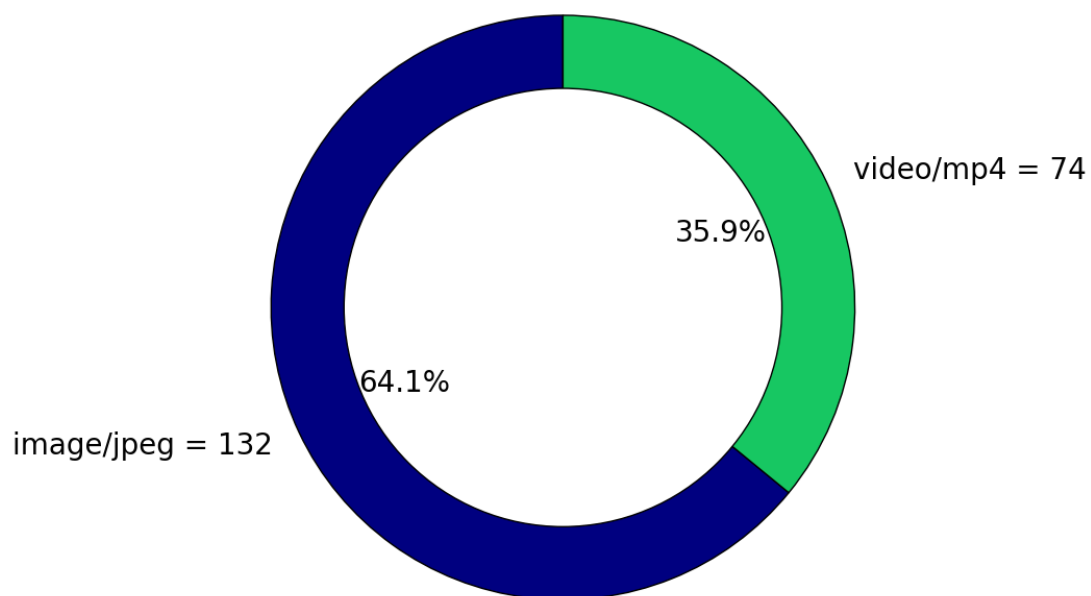

Figure A11.1 Distribution of type of media files received

Metadata was extracted from 54.9% of the media files.

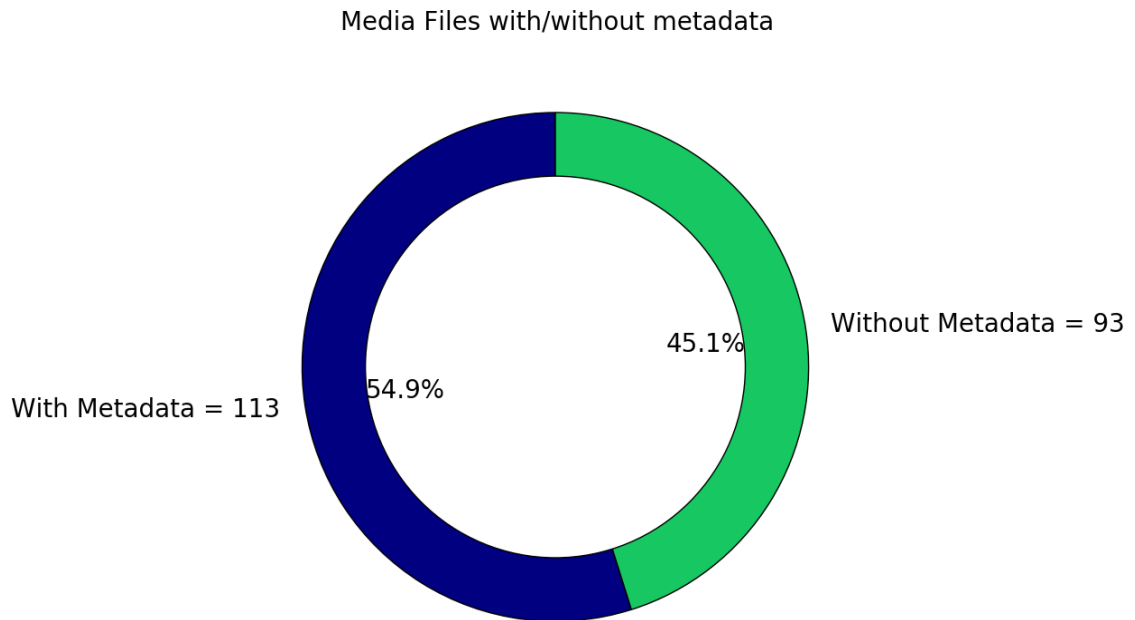
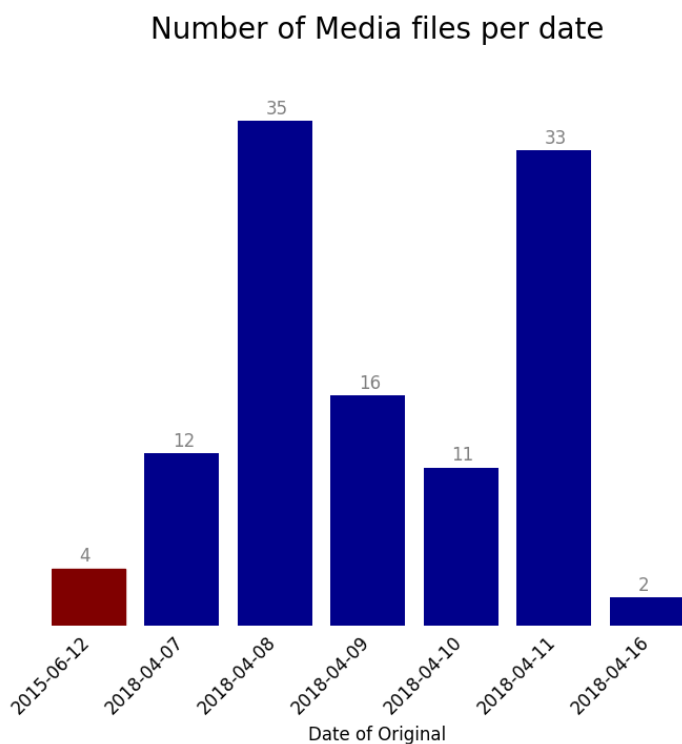
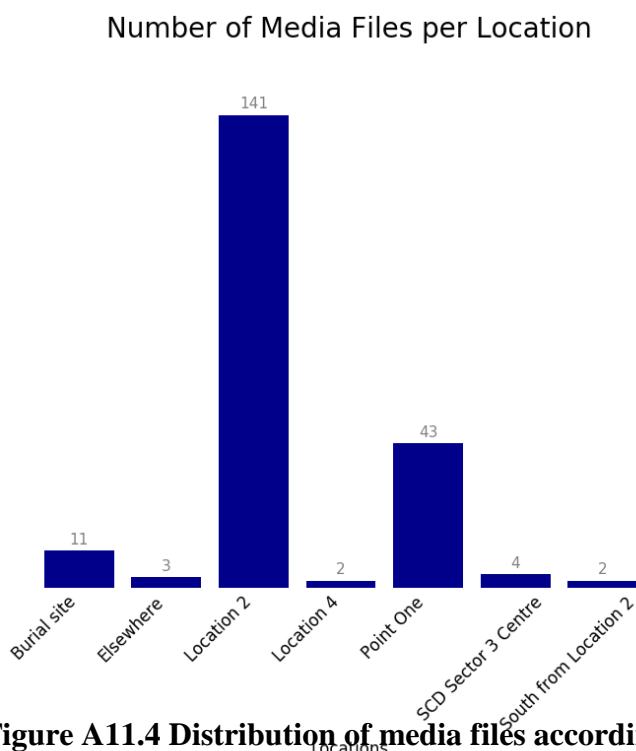

Figure A11.2 Distribution of media files with/without extracted metadata



The extracted metadata show that media files originated between 7 and 16 of April 2018, except for four files dated 12 June 2015. After inspecting the latter, the conclusion is that the content is related to the incident on 7 April 2018 in Douma and the incorrect timestamp on the metadata is likely to be due to incorrect date/time settings on the device that generated the files. In an abundance of caution, the FFM excluded those files from the analysis.

Figure A11.3 Distribution of media files according to their Date of Original. The bar marked in red belongs to four files likely to be generated with a device on which date/time setting were not properly set.



According to witness testimonies, and after evaluating the content of the files, the distribution of the images per location of origin is as shown in Figure A11.4. The majority of the images were created at Location 2 and Point One.

Figure A11.4 Distribution of media files according to the place they were recorded

According to content, the files were classified as follows:

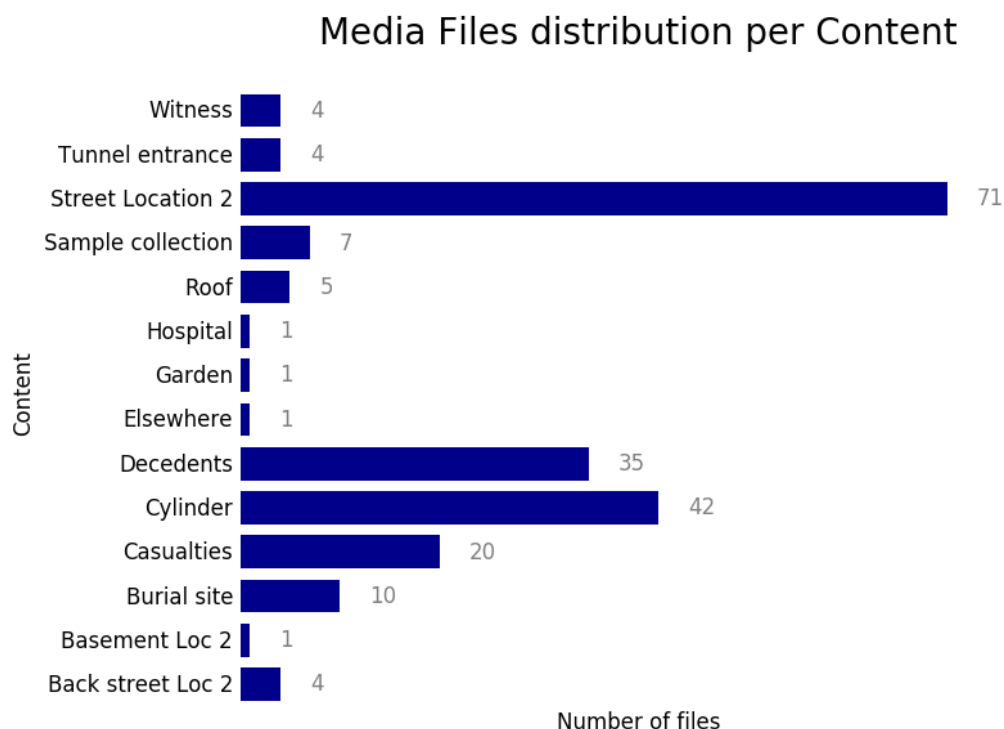

Figure A.11.5 Classification of images according to their content

A timeline was created using the content and dates of the files extracted from the metadata (see Figure A.11.6 below). From figure A.11.6 and A.11.7, it is clear that living casualties started appearing after midday on 7 April. Afterwards, there has been a gap until new casualties were reported. Then, there was another gap in time while there were no images of casualties on 8 April between 2:00 and 14:00 hours. Note that the timeline was created using only the images with available metadata.

Timeline of Media Files

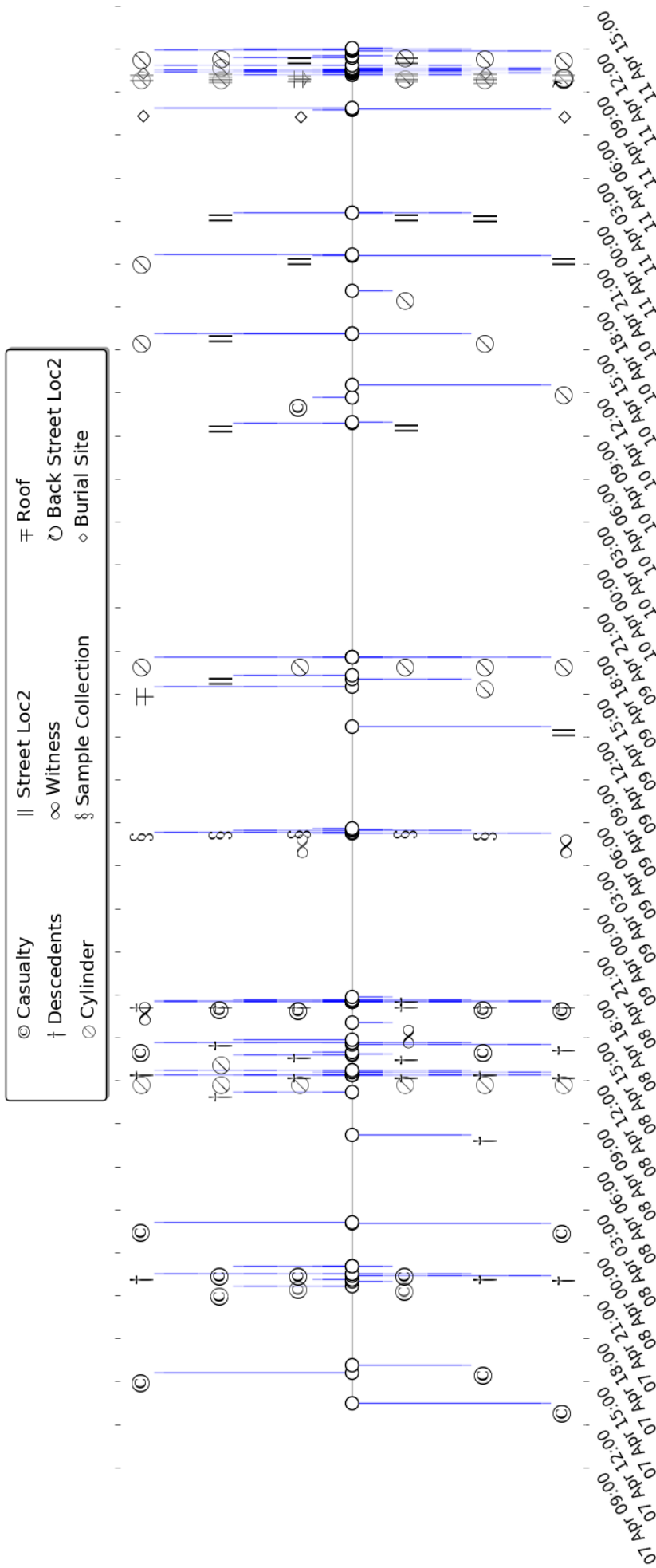

Figure A.11.6 Timeline made with the date of original of the file with extracted metadata

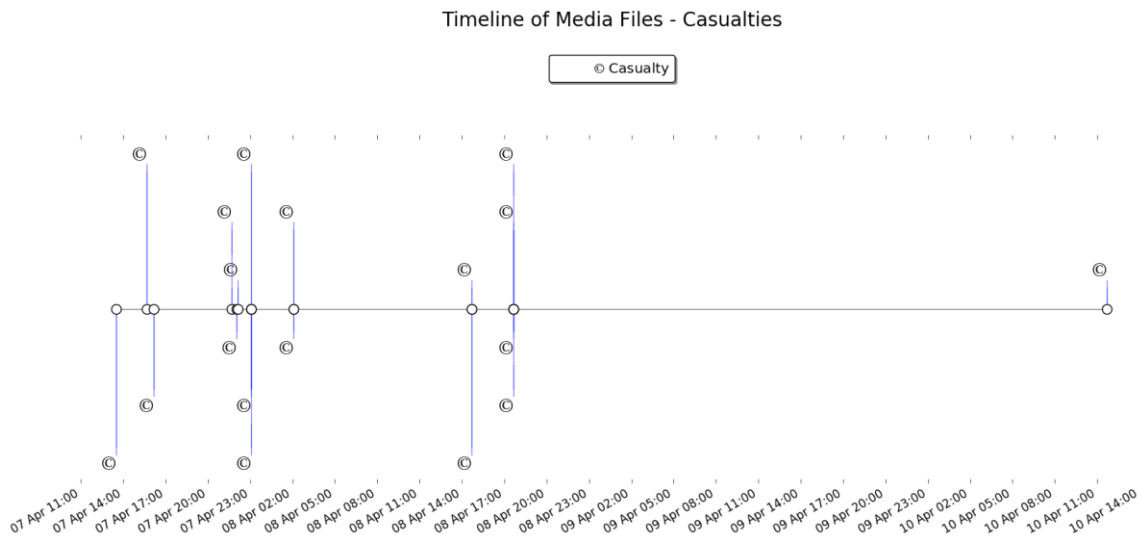

Figure A.11.7 Timeline of media files with images of living casualties. The last image on 10 April 2018 was taken by a casualty showing the evolution of clinical signs.

Figure A.11.8 shows the timeline of images depicting decedents. The first were taken between 22:00 and 23:00 on 7 April. The next group of pictures was taken on 8 April after 8:00 AM.

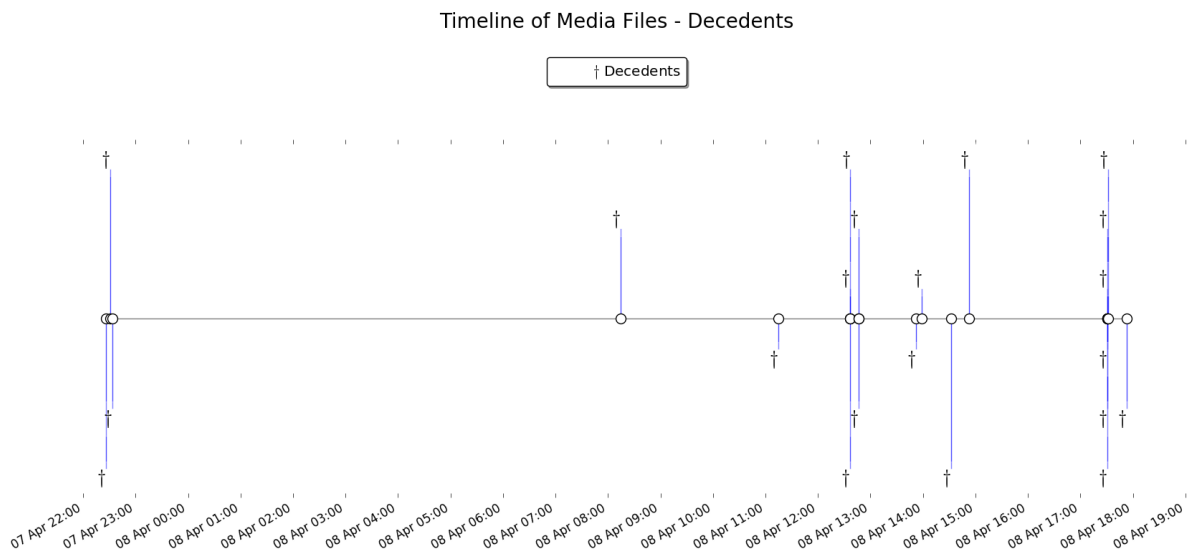

Figure A.11.8 Timeline of media files with images depicting decedents.

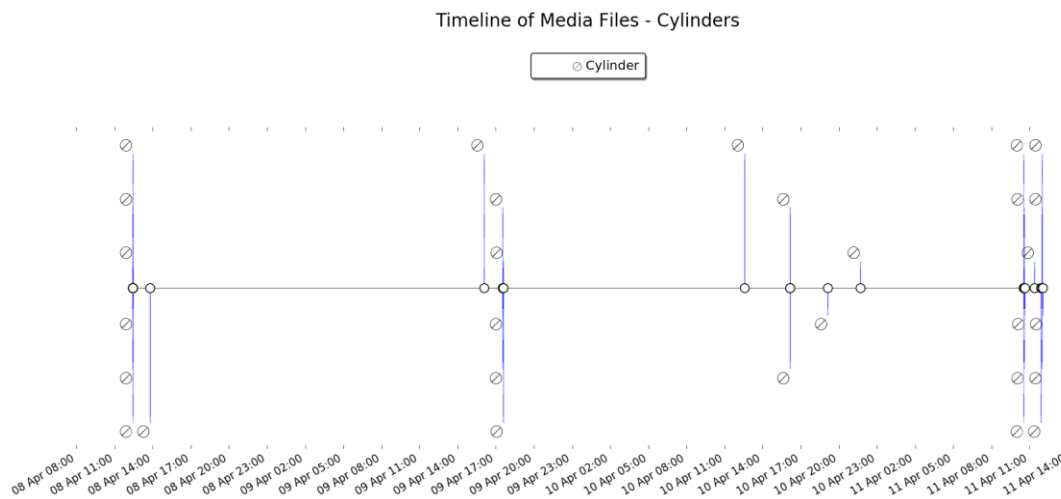

Figure A.11.9 Timeline of media files with images of cylinders

Figure A.11.9 shows the timeline of images with cylinders. Only one video showing the cylinder at Location 4 contained metadata and it was recorded on 10 April 2018 21:41:05. All other images of cylinders were taken at Location 2.

The following observations are noted by the FFM team after the analysis of digital information:

- From an examination of the metadata, the videos and photos provided by witnesses in relation to Locations 1, 2, and 4 were created at the reported time of the alleged incident.
- From the various videos showing the deceased victims throughout the interior of Location 2, some of the victims had been moved between video recordings.

ANNEX 12

EXPERTS' ANALYSES ON INDUSTRIAL-TYPE CYLINDERS

Experts' Analyses for Industrial Cylinders found in Douma at the Site of Alleged Use of 7 April 2018

- The FFM requested three independent analyses from experts recognised by their respective institutions and the international community for their knowledge, skills, and experience.
- The experts consulted came from three different countries and have expertise in engineering, ballistics, metallurgy, construction, and other relevant fields.
- The analyses were focussed on the damage observed on the industrial cylinders and their surroundings in both locations where they were found in Douma.
- The experts provided reports and numerical simulations on the impact of steel cylinders on reinforced concrete slabs, in line with the two locations observed by the FFM team members in Douma.
- The analyses included general descriptions, geometrical data, trajectory calculations, empirical calculations, and numerical simulations.
- The international experts used different methodologies and approaches for their analyses in order to produce more comprehensive results. Proprietary, commercial referenced software solutions were used for numerical simulations.
- The independent analyses results were complementary and, as such, presented in the main body of the report.
- Consultations with the international experts were conducted in accordance with OPCW confidentiality procedures.

ANNEX 13

BIBLIOGRAPHY

- [1] J. Smith, "Chlorination of Turpentine". United States Patent 3,287,241, 22 November 1966.
- [2] T. Hasselstrom and B. Hampton, "Art of Producing Chlorinated Terpenes from Turpentine". United States Patent 2,337, 043, 13 July 1938.
- [3] G. Lee and J. Morris, "Kinetics of Chlorination of Phenol," *Int. J. Air Wat. Poll.*, vol. 6, pp. 419-431, 1962.
- [4] B. T. Gowda and M. Mary, "Kinetics and mechanism of chlorination of phenol and substituted phenols by sodium hypochlorite in aqueous alkaline medium.," *Indian Journal of Chemistry*, vol. 40A, no. November, pp. 1196-1202, 2001.
- [5] J. Pickup, "Environmental Safety of Halogenated Organic By-Products from use of Active Chlorine," *Euro Chlor* 17, pp. 1-40, May 2010.
- [6] General Assembly in the 36th Session on 11 – 29 September 2017 (A/HRC/36/54).
- [7] S. A. Koehler and M. D. Freeman, "Forensic epidemiology: a method for investigating and quantifying specific causation," *Forensic Sci Med Pathol*, no. DOI 10.1007/s12024-013-9513-8.
- [8] General Assembly in the 25th Session on February 2014 (A/HRC/25/63).
- [9] W. Aldridge and C. Lovatt Evans, "The Physiological Effects and Fate of Cyanogen Chloride," 1945. [Online]. Available: <https://physoc.onlinelibrary.wiley.com>. [Accessed May 2018].
- [10] M. Mehlman, "Health Effects and Toxicity of Phosgene: Scientific Review," *Def Sci J*, vol. 37, no. 2, pp. 269-279, 1987.
- [11] R. Das and P. Blanc, "Chlorine Gas Exposure and the Lung: A Review," *Toxicology and Industrial Health*, vol. 9, no. 3, pp. 439-445, 1993.
- [12] M. Wenck and et.al., "Rapid Assessemnt of Exposure to Chlorine Released from a Train Derailment and Resulting Health Impact," <https://www.ncbi.nlm.nih.gov/pmc/articles/PMC1997246/>, 2007.
- [13] General Assembly in the 37th Session on 26 February – 23 March 2018 (A/HRC/37/72).
- [14] G. M. Fair, J. Corris, S. L. Chang, I. Weil and R. P. Burden, "The behavior of chlorine as a water disinfectant," *J. Am. Water Works Assoc*, vol. 40, p. 1051–1061, 1948.
- [15] "Toxicological Profile for Chlorine," Agency for Toxic Substances and Disease Registry, November 2010. [Online]. Available: <https://www.atsdr.cdc.gov/ToxProfiles/tp.asp?id=1079&tid=36>. [Accessed 2018].
- [16] C. White and J. Martin, "Chlorine gas inhalation: human clinical evidence of toxicity and experience in animal models," *Proceedings of the American Thoracic Society*, vol. 7(4), no. doi:10.1513/pats.201001-008SM, pp. 257-263, 2010.
- [17] G. Heinemann, F. Garrison and P. Haber, "Corrosion of steel by gaseous chlorine: Effect of time and temperature," *Industrial & Engineering Chemistry*, vol. 38, no. 5, pp. 497-499, 1946.
- [18] T. C. W. Sesselmann, "The interaction of chlorine with copper: Adsorption and surface reaction," *Surface Science Letters*, vol. 176, no. 1-2, pp. 32-66, 1986.
- [19] "Halogenated fatty acids," 2018. [Online]. Available: <http://www.cyberlipid.org/fa/acid0007.htm#3>.

- [20] OPCW, *Methods to Detect and Confirm Chlorine in Environmental Samples*, The Hague: Chlorine Response, Detection, Decontamination, and Destruction Workshop, May 2017.
- [21] B. Massa, "Acute Chlorine Gas Exposure Produces Transient Inflammation and a Progressive Alteration in Surfactant Composition with Accompanying Mechanical Dysfunction," *Toxic Appl Pharmacol*, vol. 278, no. 1, pp. 53-64, 2014.
- [22] Ford et al, "Formation of chlorinated lipids post-chlorine gas exposure," *J Lipid Research*, vol. 57, no. August, pp. 1529-1540, 2016.
- [23] B. Crow, "Simultaneous Measurement of 3-Chlorotyrosine and 3,5-Dichlorotyrosine in Whole Blood, Serum and Plasma by Isotope Dilution HPLC-MS-MS," *Journal of Analytical Toxicology*, vol. 40, pp. 264-271, 2016.
- [24] A. Ahmad, "Sarcoendoplasmic Reticulum Ca²⁺ ATPase. A Critical Target in Chlorine Inhalation-Induced Cardiotoxicity," *Am J Respir Cell Mol Biol*, vol. 52, no. 4, pp. 492-502, 2015.
- [25] M. Sochaski, "3-Chlorotyrosine and 3,5-Dichlorotyrosine as Biomarkers of Respiratory Tract Exposure to Chlorine Gas," *J Anal Toxicology*, vol. 32, no. 1, pp. 99-105, 2008.
- [26] C. Astot, "alpha-Phosphatidylglycerol chlorohydrins as Potential Biomarkers for Chlorine Gas Exposure," *Anal. Chem*, vol. 88, no. 20, pp. 9972-9979, 2016.
- [27] S. Muhsah, J. Chen and G. Hoyle, "Repair of tracheal epithelium by basal cells after chlorine-induced injury," *Respiratory Research*, vol. 13, p. 107, 2012.
- [28] T. Nakao, O. Aozasa, S. Ohta and H. Miyata, "Assessment of human exposure to PCDDs, PCDFs and Co-PCBs using hair as a human pollution indicator sample I: Development of analytical method for human hair and evaluation for exposure assessment," *Chemosphere*, vol. 48, no. 8, pp. 885-896, 2002.